



KONICA MINOLTA

The essentials of imaging

# **bizhub C252**

---

## **Quick Guide [Print Operations]**

### INDEX

---

- 1. Overview
- 2. Installing the Printer Driver
- 3. Setting Up Network Printing
- 4. Various Printing Methods
- 5. Various Settings
- 6. Troubleshooting
- 7. Appendix

# Welcome

Thank you for purchasing the Konica Minolta bizhub C252.

The bizhub C252 is equipped with an integrated printer controller that allows you to print directly from Windows-compatible computers or Macintosh computers.

This Quick Guide describes the printing functions, operations, usage, and safety precautions of the printer controller. In order to ensure that this machine is used efficiently, carefully read this manual before using the machine. In order to ensure that this machine is used safely, carefully read "Installation and Operation Precautions" in the User's Guide [Copy Operations] before using the machine.

The illustrations used in this Quick Guide may differ from the actual model.

## Trademarks and Copyright

- KONICA MINOLTA, the KONICA MINOLTA logo, and The essentials of imaging are registered trademarks of KONICA MINOLTA HOLDINGS, INC.
- PageScope and bizhub are registered trademarks of KONICA MINOLTA BUSINESS TECHNOLOGIES.
- Netscape Communications, the Netscape Communications logo, Netscape Navigator, Netscape Communicator, and Netscape are trademarks of Netscape Communications Corporation.
- Novell and Novell NetWare are registered trademarks of Novell, Inc.
- Microsoft, Windows, and Windows NT are registered trademarks of Microsoft Corporation.
- IBM is a registered trademark of International Business Machines, Inc.
- Apple, Macintosh, and Mac are registered trademarks of Apple Computer, Inc.
- Adobe, the Adobe logo, Acrobat, the Acrobat logo, PostScript, and the PostScript logo are either registered trademarks or trademarks of Adobe Systems Incorporated.
- Ethernet is a registered trademark of Xerox Corporation.
- PCL is a registered trademark of Hewlett-Packard Company Limited.
- All other product and brand names are trademarks or registered trademarks of their respective companies or organizations.
- This machine and PageScope Box Operator are based in part on the work of the Independent JPEG Group.
- Compact-VJE  
Copyright 1986-2003 VACS Corp.
- RC4<sup>®</sup> is a registered trademark or trademark of RSA Security Inc. in the United States and/or other countries.

- RSA<sup>®</sup> is a registered trademark or trademark of RSA Security Inc. RSA BSAFE<sup>®</sup> is a registered trademark or trademark of RSA Security Inc. in the United States and/or other countries.



License information

This product includes RSA BSAFE Cryptographic software from RSA Security Inc.

## OpenSSL Statement

### *OpenSSL License*

Copyright © 1998-2000 The OpenSSL Project. All rights reserved. Redistribution and use in source and binary forms, with or without modification, are permitted provided that the following conditions are met:

1. Redistributions of source code must retain the above copyright notice, this list of conditions and the following disclaimer.
2. Redistributions in binary form must reproduce the above copyright notice, this list of conditions and the following disclaimer in the documentation and/or other materials provided with the distribution.
3. All advertising materials mentioning features or use of this software must display the following acknowledgment:  
“This product includes software developed by the OpenSSL Project for use in the OpenSSL Toolkit. (<http://www.openssl.org/>)”
4. The names “OpenSSL Toolkit” and “OpenSSL Project” must not be used to endorse or promote products derived from this software without prior written permission. For written permission, please contact [openssl-core@openssl.org](mailto:openssl-core@openssl.org).
5. Products derived from this software may not be called “OpenSSL” nor may “OpenSSL” appear in their names without prior written permission of the OpenSSL Project.
6. Redistributions of any form whatsoever must retain the following acknowledgment:  
“This product includes software developed by the OpenSSL Project for use in the OpenSSL Toolkit (<http://www.openssl.org/>)”

THIS SOFTWARE IS PROVIDED BY THE OpenSSL PROJECT “AS IS” AND ANY EXPRESSED OR IMPLIED WARRANTIES, INCLUDING, BUT NOT LIMITED TO, THE IMPLIED WARRANTIES OF MERCHANTABILITY AND FITNESS FOR A PARTICULAR PURPOSE ARE DISCLAIMED. IN NO EVENT SHALL THE OpenSSL PROJECT OR ITS CONTRIBUTORS BE LIABLE FOR ANY DIRECT, INDIRECT, INCIDENTAL, SPECIAL, EXEMPLARY, OR CONSEQUENTIAL DAMAGES (INCLUDING, BUT NOT LIMITED TO, PROCUREMENT OF SUBSTITUTE GOODS OR SERVICES; LOSS OF USE, DATA, OR

PROFITS; OR BUSINESS INTERRUPTION) HOWEVER CAUSED AND ON ANY THEORY OF LIABILITY, WHETHER IN CONTRACT, STRICT LIABILITY, OR TORT (INCLUDING NEGLIGENCE OR OTHERWISE) ARISING IN ANY WAY OUT OF THE USE OF THIS SOFTWARE, EVEN IF ADVISED OF THE POSSIBILITY OF SUCH DAMAGE.

This product includes cryptographic software written by Eric Young (eay@crypt-Soft.com). This product includes software written by Tim Hudson (tjh@cryptsoft.com).

### *Original SSLeay License*

Copyright © 1995-1998 Eric Young (eay@cryptsoft.com) All rights reserved. This package is an SSL implementation written by Eric Young (eay@cryptsoft.com).

The implementation was written so as to conform with Netscapes SSL.

This library is free for commercial and non-commercial use as long as the following conditions are aheared to. The following conditions apply to all code found in this distribution, be it the RC4, RSA, lhash, DES, etc., code; not just the SSL code.

The SSL documentation included with this distribution is covered by the same copyright terms except that the holder is Tim Hudson (tjh@cryptsoft.com).

Copyright remains Eric Young's, and as such any Copyright notices in the code are not to be removed. If this package is used in a product, Eric Young should be given attribution as the author of the parts of the library used. This can be in the form of a textual message at program startup or in documentation (online or textual) provided with the package.

Redistribution and use in source and binary forms, with or without modification, are permitted provided that the following conditions are met:

1. Redistributions of source code must retain the copyright notice, this list of conditions and the following disclaimer.
2. Redistributions in binary form must reproduce the above copyright notice, this list of conditions and the following disclaimer in the documentation and/or other materials provided with the distribution.
3. All advertising materials mentioning features or use of this software must display the following acknowledgement:  
"This product includes cryptographic software written by Eric Young (eay@crypt-soft.com)"  
The word 'cryptographic' can be left out if the rouines from the library being used are not cryptographic related.
4. If you include any Windows specific code (or a derivative thereof) from the apps directory (application code) you must include an acknowledgement:  
"This product includes software written by Tin Hudson (tjh@cryptsoft.com)"

THIS SOFTWARE IS PROVIDED BY ERIC YOUNG “AS IS” AND ANY EXPRESS OR IMPLIED WARRANTIES, INCLUDING, BUT NOT LIMITED TO, THE IMPLIED WARRANTIES OF MERCHANTABILITY AND FITNESS FOR A PARTICULAR PURPOSE ARE DISCLAIMED. IN NO EVENT SHALL THE AUTHOR OR CONTRIBUTORS BE LIABLE FOR ANY DIRECT, INDIRECT, INCIDENTAL, SPECIAL, EXEMPLARY, OR CONSEQUENTIAL DAMAGES (INCLUDING, BUT NOT LIMITED TO, PROCUREMENT OF SUBSTITUTE GOODS OR SERVICES; LOSS OF USE, DATA, OR PROFITS; OR BUSINESS INTERRUPTION) HOWEVER CAUSED AND ON ANY THEORY OF LIABILITY, WHETHER IN CONTRACT, STRICT LIABILITY, OR TORT (INCLUDING NEGLIGENCE OR OTHERWISE) ARISING IN ANY WAY OUT OF THE USE OF THIS SOFTWARE, EVEN IF ADVISED OF THE POSSIBILITY OF SUCH DAMAGE.

The licence and distribution terms for any publically available version or derivative of this code cannot be changed. i.e. this code cannot simply be copied and put under another distribution licence [including the GNU Public Licence.]

## **Copyright**

© 2006 Konica Minolta Business Technologies, Inc. All Rights Reserved.

### **Note**

- This Quick Guide may not be reproduced in part or in full without permission.
- Konica Minolta Business Technologies, Inc. will not be held liable for any incidents caused by using this printing system or Quick Guide.
- Information included in this Quick Guide is subject to change without notice.
- Konica Minolta Business Technologies, Inc. maintains the copyright of the printer drivers.

## SOFTWARE LICENSE AGREEMENT

This package contains the following materials provided by Konica Minolta Business Technologies, Inc. (KMBT): software included as part of the printing system, the digitally-encoded machine-readable outline data encoded in the special format and in the encrypted form (“Font Programs”), other software which runs on a computer system for use in conjunction with the Printing Software (“Host Software”), and related explanatory written materials (“Documentation”). The term “Software” shall be used to describe Printing Software, Font Programs and/or Host Software and also include any upgrades, modified versions, additions, and copies of the Software.

The Software is being licensed to you under the terms of this Agreement.

KMBT grants to you a non-exclusive sublicense to use the Software and Documentation, provided that you agree to the following:

1. You may use the Printing Software and accompanying Font Programs for imaging to the licensed output device(s), solely for your own internal business purposes.
2. In addition to the license for Font Programs set forth in Section 1 (“Printing Software”) above, you may use Roman Font Programs to reproduce weights, styles, and versions of letters, numerals, characters and symbols (“Typefaces”) on the display or monitor for your own internal business purposes.
3. You may make one backup copy of the Host Software, provided your backup copy is not installed or used on any computer. Notwithstanding the above restrictions, you may install the on any number of computers solely for use with one or more printing systems running the Printing Software.
4. You may assign its rights under this Agreement to an assignee of all of Licensee’s right and interest to such Software and Documentation (“Assignee”) provided you transfer to Assignee all copies of such Software and Documentation Assignee agrees to be bound by all of the terms and conditions of this Agreement.
5. You agree not to modify, adapt or translate the Software and Documentation.
6. You agree that you will not attempt to alter, disassemble, decrypt, reverse engineer or decompile the Software.
7. Title to and ownership of the Software and Documentation and any reproductions thereof shall remain with KMBT and its licensor.
8. Trademarks shall be used in accordance with accepted trademark practice, including identification of the trademark owner’s name. Trademarks can only be used to identify printed output produced by the Software. Such use of any trademark does not give you any rights of ownership in that trademark.

9. You may not rent, lease, sublicense, lend or transfer versions or copies of the Software Licensee does not use, or Software contained on any unused media, except as part of the permanent transfer of all Software and Documentation as described above.
10. IN NO EVENT WILL KMBT OR ITS LICENSOR BE LIABLE TO YOU FOR ANY CONSEQUENTIAL, INCIDENTAL INDIRECT, PUNITIVE OR SPECIAL DAMAGES, INCLUDING ANY LOST PROFITS OR LOST SAVING, EVEN IF KMBT HAS BEEN ADVISED OF THE POSSIBILITY OF SUCH DAMAGES, OR FOR ANY CLAIM BY ANY THIRD PARTY. KMBT OR ITS LICENSOR DISCLAIMS ALL WARRANTIES WITH REGARD TO THE SOFTWARE, EXPRESS OR IMPLIED, INCLUDING, WITHOUT LIMITATION IMPLIED WARRANTIES OF MERCHANTABILITY, FITNESS FOR A PARTICULAR PURPOSE, TITLE AND NON-INFRINGEMENT OF THIRD PARTY RIGHTS. SOME STATES OR JURISDICTIONS DO NOT ALLOW THE EXCLUSION OR LIMITATION OF INCIDENTAL, CONSEQUENTIAL OR SPECIAL DAMAGES, SO THE ABOVE LIMITATIONS MAY NOT APPLY TO YOU.
11. Notice to Government End Users: The Software is a “commercial item,” as that term is defined at 48 C.F.R.2.101, consisting of “commercial computer software” and “commercial computer software documentation,” as such terms are used in 48 C.F.R. 12.212. Consistent with 48 C.F.R. 12.212 and 48 C.F.R. 227.7202-1 through 227.7202-4, all U.S. Government End Users acquire the Software with only those rights set forth herein.
12. You agree that you will not export the Software in any form in violation of any applicable laws and regulations regarding export control of any countries.



# Contents

## Welcome

Copyright .....	x-4
<b>SOFTWARE LICENSE AGREEMENT .....</b>	<b>x-5</b>
<b>Contents .....</b>	<b>x-7</b>
<b>About this Quick Guide .....</b>	<b>x-10</b>
C252 User's Guides .....	x-10
Notations .....	x-10
Screen Images in This Quick Guide .....	x-10
Using This Quick Guide .....	x-11

## 1 Overview

<b>1.1 Printer Controller .....</b>	<b>1-1</b>
Role of the Printer Controller .....	1-1
Available Printer Controller Functions .....	1-1
Machine Modes .....	1-2
Printing Flow .....	1-3
Flow of the Computer Faxing Operation .....	1-4
<b>1.2 Operation Environment .....</b>	<b>1-5</b>
Compatible Computers and Operating Systems .....	1-5
Compatible Interfaces .....	1-6
<b>1.3 Setting Up the System .....</b>	<b>1-8</b>
To set up the printing system .....	1-8

## 2 Installing the Printer Driver

<b>2.1 Printer Drivers and Supported Operating Systems .....</b>	<b>2-1</b>
<b>2.2 When Used With Windows .....</b>	<b>2-2</b>
Automatic Installation Using the Installer .....	2-3
To install the printer driver .....	2-4
Installing the Printer Driver Using the Add Printer Wizard .....	2-6
For Windows XP/Server 2003 .....	2-6
For Windows 98SE/Me/2000/NT 4.0 .....	2-9
Installing the Printer Driver Using Plug and Play .....	2-11
For Windows 98SE .....	2-11
For Windows Me/2000 .....	2-12
For Windows XP/Server 2003 .....	2-13
Uninstalling the Printer Driver .....	2-14
<b>2.3 When Used With Macintosh .....</b>	<b>2-16</b>
Installing the Printer Driver .....	2-16



For Mac OS X .....	2-16
Selecting a Printer .....	2-18
For Mac OS X .....	2-18
For Mac OS 9.2 .....	2-21
Uninstalling the Printer Driver .....	2-23
For Mac OS X .....	2-23
For Mac OS 9.2 .....	2-24

### 3 Setting Up Network Printing

<b>3.1 Overview of Network Functions .....</b>	<b>3-1</b>
Network Functions .....	3-1
Features of the Network Functions .....	3-2
Network Connection Methods That Can Be Selected in Each	
Windows Operating System .....	3-3
Network Printing from a Windows Operating System .....	3-3
Network Printing in a NetWare Environment .....	3-4
<b>3.2 Accessing PageScope Web Connection .....</b>	<b>3-5</b>
To access PageScope Web Connection .....	3-5

### 4 Various Printing Methods

<b>4.1 Printing Operations .....</b>	<b>4-1</b>
For Windows .....	4-1
Test Printing .....	4-4
For Macintosh .....	4-5
For Mac OS X .....	4-5
For Mac OS 9.2 .....	4-6
<b>4.2 Setting the Printing Functions .....</b>	<b>4-7</b>
Function List .....	4-7
Function Overview .....	4-9
Orientation .....	4-9
Original Size and Output Size .....	4-10
Zoom (Enlargement and Reduction) .....	4-11
Input Tray (Paper Source) .....	4-12
Paper Type .....	4-12
Print Type (Duplex Printing/Booklet Printing) .....	4-13
Printing Multiple Pages on One Page .....	4-14
Stapling and Hole Punching .....	4-15
Output Method (Job Management) .....	4-16
Sorting (Collating) and Classifying (Offset) .....	4-16
Skip Blank Pages (Saving Paper) .....	4-17
Front Cover, Back Cover, and Transparency Interleave .....	4-17
Per Page Setting .....	4-18
Chapter .....	4-18



Overlay .....	4-18
Watermark .....	4-19
Copy Protect .....	4-19
Quality Adjustment .....	4-20
Use Printer Fonts (Substitute Fonts) .....	4-20
User Authentication .....	4-20
Account Track .....	4-21

## 5 Various Settings

<b>5.1 Print Reports .....</b>	<b>5-1</b>
To Print .....	5-1
<b>5.2 Printing on Banner Paper .....</b>	<b>5-3</b>
Paper .....	5-3
Paper types .....	5-3
Printer Drivers and Supported Operating Systems .....	5-3
Specifying Printer Driver Settings .....	5-3
To specify printer driver settings .....	5-3
Printing .....	5-5
To print .....	5-5

## 6 Troubleshooting

<b>6.1 Unable To Print .....</b>	<b>6-1</b>
<b>6.2 Unable To Specify Desired Settings or Unable To Print as Specified .....</b>	<b>6-3</b>
<b>6.3 Error Message .....</b>	<b>6-5</b>

## 7 Appendix

<b>7.1 Specifications .....</b>	<b>7-1</b>
<b>7.2 Configuration Page .....</b>	<b>7-3</b>
<b>7.3 Font List .....</b>	<b>7-4</b>
PCL Font List .....	7-4
PS Font List .....	7-5
Demo Page .....	7-6

## About this Quick Guide

This Quick Guide contains information for using the printing functions of the Konica Minolta printer controller. For details on the copy functions, scanning functions, box functions, fax functions, and printer functions refer to the respective User's Guide.

This Quick Guide is aimed at users who already have a basic knowledge of computer and copier operations. For Windows or Macintosh operating system and application operations, refer to the operation manual of the respective product.

### C252 User's Guides

The User's Guides for this machine are divided by function and consist of the following:

User's Guide	Details
Print Operations Quick Guide	This guide describes the basic information of the printer functions.
Print Operations	This guide describes the detailed information of the printer functions. Read this guide when the necessary information is not described in the Print Operations Quick Guide.
Network Scanner Operations	Read this guide when using this machine as a scanner.
Box Operations	Read this guide when using this machine's box functions.
Facsimile Operations	Read this guide when using this machine's fax functions.
Network Facsimile Operations	Read this guide when using this machine's network fax (Internet fax, SIP fax, IP address fax) functions.

### Notations

Product Name	
KONICA MINOLTA C252 This machine	This machine, copier, or printer
Integrated network controller	Network controller
Printer controller, including this machine, and printing system	Printing system
Microsoft Windows	Windows

### Screen Images in This Quick Guide

Unless stated otherwise, the printer driver functions are described using the printer driver for Windows XP.

## Using This Quick Guide

Subject titles

Explains the operation procedure.

Windows, dialog boxes, icons, and function names displayed on the screen are enclosed in “ ”.

Button names displayed on the screen are enclosed in [ ].

Contents displayed on a screen.

Additional explanation of the text is given.

4

---

### 4 Various Printing Methods

#### 4.1 Printing Operations

**For Windows**  
Data can be printed from an application.  
Print jobs are specified from the application software.

- 1 Open the data in the application, “File”, and then click “Print”.
- 2 Check that the printer name has been selected.  
If the printer is not selected, click the [▼] and select the printer.

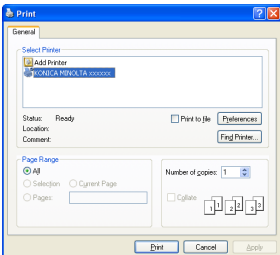

- 3 Specify the page range and the number of copies to print.

⋮  
**Note**  
*The Print dialog box differs depending on the application.*

---

C252 4-1

(The page shown above is an example only.)



# 1 Overview

## 1.1 Printer Controller

The printer controller is a device for performing printing functions and network printing functions with this machine.

### Role of the Printer Controller

The printer controller is built into the machine.

You can print from applications on the computer connected to the printing system. When using this machine as a network printer, you can print from applications on the computer.

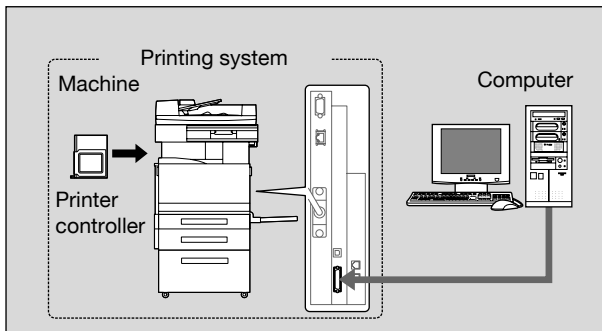

### Available Printer Controller Functions

The printer controller provides the following functions.

- Printing from a computer (using the PCL printer driver or PS printer driver)
- Support of network protocols including TCP/IP, NetBEUI, IPX/SPX, and AppleTalk
- Direct printing over a network using SMB (Windows), LPR, and IPP printing
- Access to settings for this machine and the printer controller from a client computer over the network (using a Web browser)
- Control of the number of pages printed (“User Authentication” and “Account Track” functions)
- Fax operations using a computer (fax transmission)



### Note

*To perform fax operations, optional fax kit FK-502 is required.*

## Machine Modes

The printer driver settings are mainly set using a computer, however, the font list can be printed, and the printer controller settings and default print settings can be set using the control panel of this machine. In addition, fax and scanning operations can be used by switching the mode.

To switch between modes, press the mode keys on the control panel.

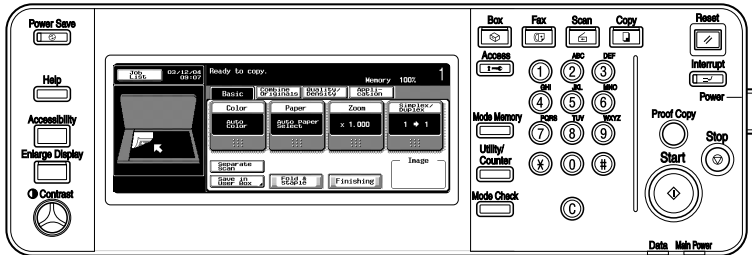

### [Copy]

This machine can be used as a copier.

### [Scan]

This machine can be used as a scanner.

### [Fax]

This machine can be used for faxing.

### [Box]

This machine can be used to store jobs and as a document folder for forwarding data to a computer over the network.



### Note

*You can use this machine as a printer in all modes.*

*Change the default print settings in the Utility mode.*

## Printing Flow

When using this printing system as a printer, the flow of the main process is described below.

Print commands transmitted from the application are received by the printer driver.

Data is transmitted to this machine over a parallel interface (IEEE 1284) when this machine is used as a local printer, over a USB interface when this machine is used as a USB printer, or over an Ethernet interface (TCP/IP, IPX/SPX or AppleTalk) when this machine is used as a network printer. The data is then delivered from this machine to the printer controller, which performs image rasterization (development of output characters and images to bitmap data). Finally, this data is printed from this machine.



### Note

*The parallel and USB interfaces cannot be used simultaneously.*

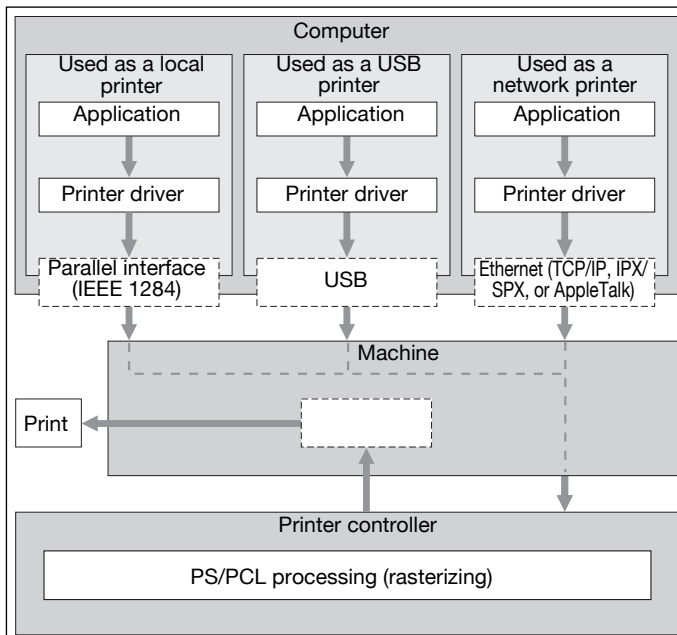

Original documents can be scanned in the copy function or network scan function while this machine is operating as a printer.

To use this machine as a copier, press the [Copy] key on the control panel.



When a print job is received during copying, the data is stored in the memory of this machine. When copying is complete, the print job is automatically printed.

### Flow of the Computer Faxing Operation

Conventionally, faxes are sent by loading an original into a fax machine and sending it.

With computer faxing, you can send a fax directly from your computer without using any paper.

Transmission commands sent from the application are received by the printer driver.

Data is transmitted to this machine over a parallel interface (IEEE 1284) when this machine is used as a local printer, over a USB interface when this machine is used as a USB printer, or over an Ethernet interface (TCP/IP, IPX/SPX or AppleTalk) when this machine is used as a network printer. The data is then delivered from this machine to the printer controller, which performs image rasterization (development of output characters and images to bitmap data). Finally, this data is stored in the memory of this machine and transmitted like a conventional fax job.

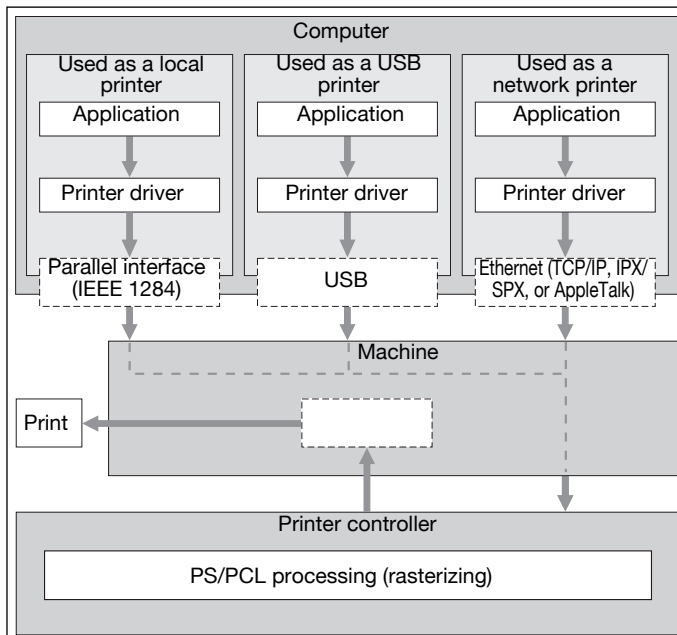

## 1.2 Operation Environment

The system requirements for using this printing system and the interfaces used for connection are explained below.

### Compatible Computers and Operating Systems

Check that the computer being connected meets the following conditions.

#### Windows

Item	Operating Environment
Operating System	Windows 98 Second Edition, Windows Me, Windows NT 4.0 (Service Pack 6a or later), Windows 2000 Professional (Service Pack 4 or later), Windows XP Home Edition/Windows XP Professional (Service Pack 2 or later), or Windows Server 2003
Processor	Pentium or higher
Memory	Capacity recommended for the operating system With sufficient memory resources in the operating system and application being used
Drive	CD-ROM
Web Browser (when using PageScope Web Connection)	Microsoft Internet Explorer 6 or later recommended (JavaScript enabled, Cookies enabled) Microsoft XML Parser MSXML3.X must be installed when using Internet Explorer 5.5. Netscape Navigator 7.02 or later (JavaScript enabled, Cookies enabled) Macromedia® Flash® (If "Flash" is selected in View Mode, version 7.0 or later plugin is required.)

#### Macintosh

Item	Operating Environment
Operating System	Mac OS 9.2, Mac OS X 10.2, Mac OS X 10.3, or Mac OS X 10.4
Processor	PowerPC, Intel Processor
Memory	Capacity recommended for the operating system
Drive	CD-ROM
Web Browser (when using PageScope Web Connection)	Netscape Navigator 7.02 or later (JavaScript enabled, Cookies enabled) Macromedia® Flash® (If "Flash" is selected in View Mode, version 7.0 or later plugin is required.)

## Compatible Interfaces

The various interfaces that can be used to connect this printing system to a computer are described below.

### Ethernet Interface

Connect when using this printing system as a network printer.

Supports 10Base-T and 100Base-TX standards. In addition, the Ethernet interface supports the TCP/IP (LDP/LPR, peer-to-peer), IPX/SPX (NetWare) and AppleTalk (EtherTalk) protocols.

### Parallel Interface (optional)

Connect when using this printing system as a local printer.

A computer running Windows and an IEEE 1284 parallel cable are required for connection. Use a parallel cable that uses a terminal with an Amphenol 36-pin male connector.

The parallel interface supports the compatible, nibble, and ECP modes.

### USB Interface (optional)

Connect when using this printing system as a network printer.

The USB interface can be connected to a computer running Windows. A USB cable is required for connection. Use a type A (4 pin, male) or type B (4 pin, male) USB cable. A USB cable measuring 3 meters or less is recommended.

The parallel and USB interfaces cannot be used simultaneously. You can switch the interfaces in the administrator mode.

### Connection Diagram

The printer cables can be connected to each port at the back of this machine.

Machine (rear view)

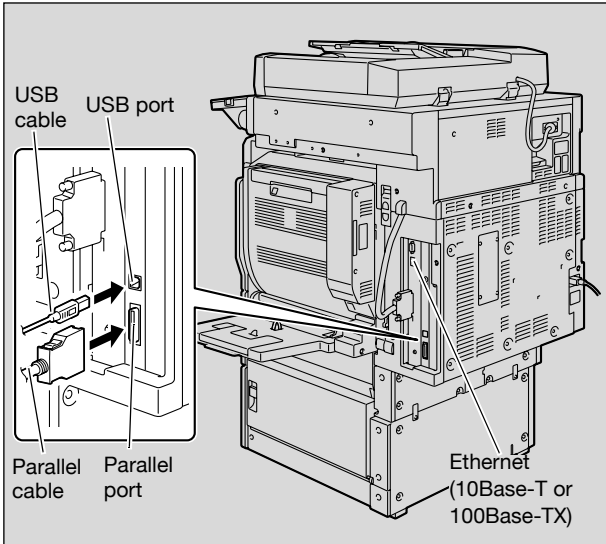

## 1.3 Setting Up the System

In order to use this printing system, it must first be set up.

Setup consists of connecting this machine to a computer and installing the printer driver onto the computer being used.

### To set up the printing system

Setup of the printing system as described below.

- 1 Connect this machine to a computer. (Refer to “Compatible Interfaces” on page 1-6.)
- 2 Install the printer driver. (Refer to “Installing the Printer Driver” on page 2-1.)
- 3 When using a network connection, set up the network. (Refer to “Setting Up Network Printing” on page 3-1.)
- 4 Check the setup by printing a test page. (Refer to “Test Printing” on page 4-4.)
- 5 Install the screen fonts.
  - The User Software CD-ROM and the PostScript Printer Driver CD-ROM contain the Latin TrueType fonts as screen fonts.
  - Install the screen fonts after adding the operating system standard fonts.
  - For details, refer to Help of the operating system.
  - The CD-ROM “Screenfont” or “Screenfonts” folder contains the screen fonts.
  - The Macintosh fonts are compressed. Install the fonts after decompressing them.

Installation of the printer driver may differ depending on the connection method used with this machine in addition to the operating system of the computer and the type of printer driver being used.



#### **Detail**

*For details on connecting this machine to a computer, refer to “Compatible Interfaces” on page 1-6.*

**Note**

*To update an existing printer driver, delete the existing printer driver first. For details, refer to “Uninstalling the Printer Driver” on page 2-14 and page 2-23.*

*As necessary, set the interface timeout settings and parallel interface mode (Compatible, Nibble, or ECP) in the Utility mode on the control panel. For details, refer to “Printer Settings in Administrator Mode” on the User’s Guide [Print Operations].*

*When using the parallel or USB local port, you must select the port being used. For details, refer to “IEEE 1284/USB” on the User’s Guide [Print Operations].*



## 2 Installing the Printer Driver

### 2.1 Printer Drivers and Supported Operating Systems

In order to use this printing system, the printer driver must be installed. The printer driver is a program that controls the processing of data for output. Install the printer driver onto the computer from the provided CD-ROM.

The printer drivers included on the CD and the supported computer operating systems are listed below. Install the required printer driver.

Printer Driver	Page Description Language	Supported Operating Systems
Konica Minolta PCL Driver	PCL (PCL XL)	Windows 98 Second Edition, Windows Me, Windows NT 4.0 (Service Pack 6a), Windows 2000 Professional (Service Pack 4 or later), Windows XP Home Edition/Professional (Service Pack 2 or later), and Windows Server 2003
Konica Minolta PostScript Driver	PostScript 3 Emulation	Windows NT 4.0 (Service Pack 6a), Windows 2000 Professional (Service Pack 4 or later), Windows XP Home Edition/Professional (Service Pack 2 or later), Windows XP Professional x64, Windows Server 2003, and Windows Server 2003 x64
PostScript PPD Driver		Windows 98 Second Edition, Windows Me Mac OS 9.2 or later, Mac OS X 10.2, Mac OS X 10.3, and Mac OS X 10.4

\* The User Software CD-ROM contains the PCL printer driver, and the PostScript Printer Driver CD-ROM contain the PostScript driver.



## 2.2 When Used With Windows

The installation procedure for the Windows printer driver differs depending on how this machine is connected to the computer and depending on which printer driver is used. The installation method also differs depending on the version of Windows that you are using. Refer to the table below for the appropriate procedure for installing the printer driver on your computer.

Printer Driver	Connection Method	Refer To
Konica Minolta PCL Driver Konica Minolta PostScript Driver	All connection methods	"Automatic Installation Using the Installer" on page 2-3
Konica Minolta PCL Driver Konica Minolta PostScript Driver PostScript PPD Driver	Network connection	"Installing the Printer Driver Using the Add Printer Wizard" on page 2-6 "For Windows 98SE/Me/2000/NT 4.0" on page 2-9 "For Windows XP/Server 2003" on page 2-6
	Parallel connection	"Installing the Printer Driver Using Plug and Play" on page 2-11 "For Windows 98SE" on page 2-11 "For Windows Me/2000" on page 2-12 "For Windows XP/Server 2003" on page 2-13
		"Installing the Printer Driver Using the Add Printer Wizard" on page 2-6 "For Windows 98SE/Me/2000/NT 4.0" on page 2-9 "For Windows XP/Server 2003" on page 2-6
USB connection	"Installing the Printer Driver Using Plug and Play" on page 2-11 "For Windows 98SE" on page 2-11 "For Windows Me/2000" on page 2-12 "For Windows XP/Server 2003" on page 2-13	



### Note

*For details on installing the printer driver in a network environment, refer to "Setting Up Network Printing" on page 3-1. Because it is necessary to specify other network settings in advance when installing the printer driver using a network connection, install it using a local connection at this time.*

*To install the printer driver under Windows XP, Windows Server 2003, Windows 2000, or Windows NT 4.0, log on using a user name that is authorized by the administrator.*

*To connect this machine to a computer using a parallel connection or a USB connection, the optional local interface kit is required.*

## Automatic Installation Using the Installer

With the installer, this machine is detected to determine whether it is connected by USB or is on the same TCP/IP network as the computer, and then the required printer driver is automatically installed. You can also manually specify the printer driver to be installed.



### Note

*Since this machine is automatically detected with a network connection, be sure to set the IP address of this machine before connecting it. For details on specifying the settings, refer to “Setting the IP Address for This Machine” on the User’s Guide [Print Operations].*

*When installing on Windows NT 4.0, 2000, XP, or Server 2003, administrator permissions are required.*

*If the wizard starts up in order to add new hardware with a USB or parallel connection, click [Cancel].*

*For IPP printing, it is not necessary to install the printer driver at this time since IPP printing setup is performed when the printer driver is installed. For further details on IPP printing, refer to “IPP Printing (Windows 2000/XP/Server 2003)” on the User’s Guide [Print Operations].*

## Installer Operating Environment

Item	Operating Environment
Operating System	Windows 98 Second Edition, Windows Me, Windows NT 4.0 (Service Pack 6a or later)*, Windows 2000 Professional (Service Pack 4 or later), Windows XP Home Edition/Windows XP Professional (Service Pack 2 or later), or Windows Server 2003
Processor	Pentium 300 MHz or higher recommended
Memory	64 MB or more (128 MB or more recommended)

\* With Windows NT 4.0, in order to install a machine that is connected directly to a network using the TCP/IP protocol, Windows TCP/IP Printing Services must first be installed on the computer being used.

## To install the printer driver

- 1 Insert the Windows printer driver CD-ROM into the computer's CD-ROM drive.
  - For the User Software CD-ROM (for a PCL driver), check that the installer starts up, and then continue with step 2.
  - For the PostScript Printer Driver CD-ROM (Win) (for a PS driver), double-click “UserInst.exe” in the Driver folder on the CD-ROM, and then continue with step 3.
- 2 Click “Printer Install”.

The installation of the printer driver starts.
- 3 Click the [AGREE] button if you agree with all terms and conditions of the license agreement.
  - If you do not agree with the terms and conditions of the license agreement, the software cannot be installed.
  - You can change the display language of the installer box in the lower-left corner.



- 4 When the setup selection dialog box appears, click the “Install printers/MFPs” button, and then click the [Next] button.

The connected printers and copiers are detected.

- 5 Select this machine and proceed with the installation.  
Follow the on-screen instructions to complete the installation.

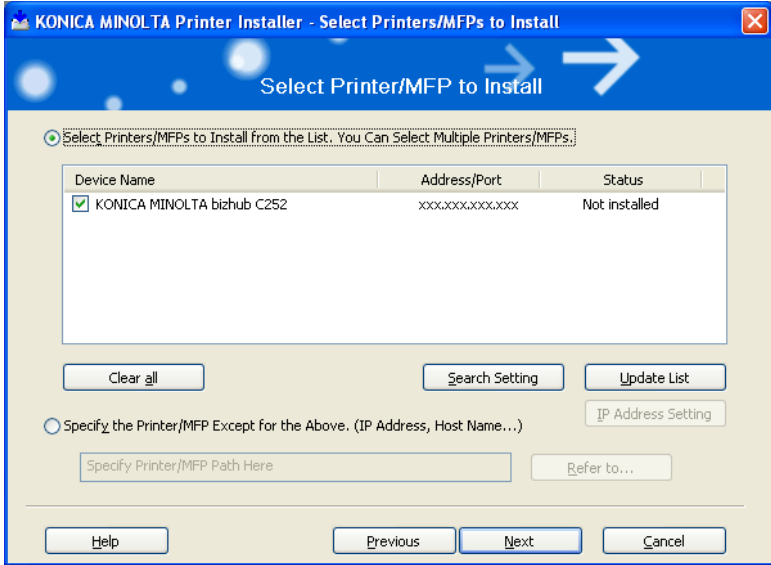

- If the connection of this machine cannot be recognized or for parallel connections, the machine will not be listed. When this occurs, select "Specify the Printer/MFP Except for the Above. (IP Address, Host Name)", and then specify this machine directly.

## Installing the Printer Driver Using the Add Printer Wizard



### Note

*For IPP printing, it is not necessary to install the printer driver at this time since IPP printing setup is performed when the printer driver is installed.*

*For further details on IPP printing, refer to “IPP Printing (Windows 2000/XP/Server 2003)” on the User’s Guide [Print Operations].*



### Note

*For details on installing the printer driver in a network environment, refer to “Setting Up Network Printing” on page 3-1. Because it is necessary to specify other network settings in advance when installing the printer driver using a network connection, install it using a local connection at this time.*

## For Windows XP/Server 2003

- 1 Insert the Windows printer driver CD-ROM into the computer’s CD-ROM drive.
  - Konica Minolta PCL Driver: User Software CD-ROM
  - Konica Minolta PostScript Driver: PostScript Printer Driver CD-ROM
  
- 2 Click the [Start] button, and then click “Printers and Faxes”.
  - If “Printers and Faxes” does not appear in the Start menu, open the Control Panel from the Start menu, select “Printers and Other Hardware”, and then select “Printers and Faxes”.

- 3 For Windows XP, click “Add a printer” on the “Printer Tasks” menu.
  - For Windows Server 2003, double-click the “Add Printer” icon.

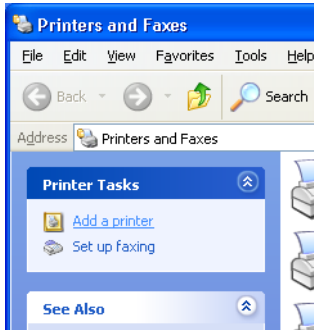

Windows XP

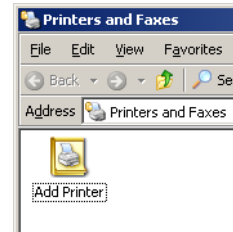

Windows Server 2003

The Add Printer Wizard starts up.

- 4 Click the [Next] button.
- 5 Select “Local printer attached to this computer”, and then click the [Next] button.
  - Clear the “Automatically detect and install my Plug and Play printer” check box.

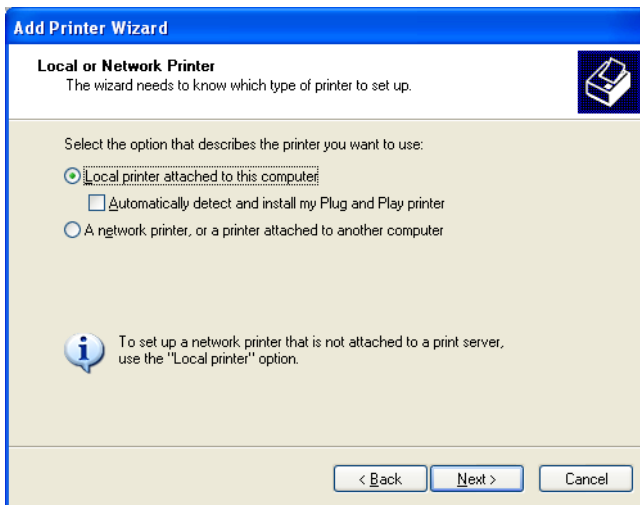

- 6 The Select Printer Port dialog box appears. Select “LPT1” here, and then click the [Next] button.

- 7 Click the [Have Disk] button.
- 8 Click the [Browse] button.
- 9 Specify the folder on the CD-ROM that contains the printer driver for the operating system that you are using, and then click the [OK] button.
  - Konica Minolta PCL Driver: User Software CD-ROM “Driver\bizhubC252\_C252P” folder
  - Konica Minolta PostScript Driver: PostScript Printer Driver CD-ROM “Driver\bizhubC252” folder
- 10 Click the [OK] button.
  - The “Printers” list appears.

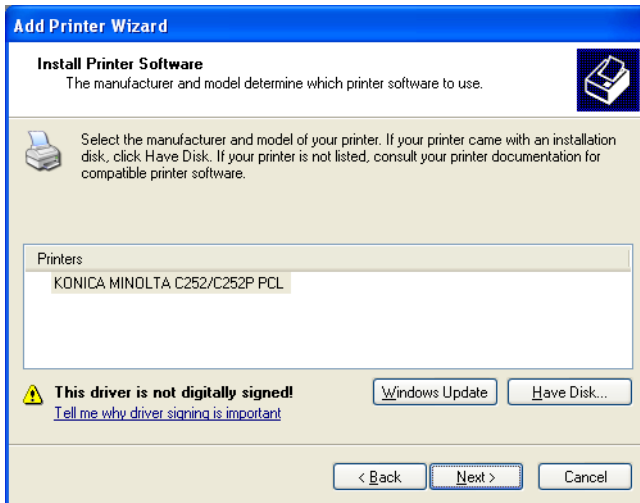

- 11 Click the [Next] button.
- 12 Follow the on-screen instructions.
  - When the Digital Signature message appears, click the [Continue] button.
  - When using a network connection, perform a test print after the network settings have been specified.
- 13 When installation is complete, make sure that the icon of the installed printer appears in the Printers and Faxes window.
- 14 Remove the CD-ROM from the CD-ROM drive.

This completes the printer driver installation.

**For Windows 98SE/Me/2000/NT 4.0**

- 1 Insert the Windows printer driver CD-ROM into the computer's CD-ROM drive.
  - Konica Minolta PCL Driver: User Software CD-ROM
  - Konica Minolta PostScript Driver: PostScript Printer Driver CD-ROM
- 2 Click the [Start] button, point to “Settings”, and then click “Printers”. The Printers window appears.
- 3 Double-click the “Add Printer” icon. The Add Printer Wizard starts up.
- 4 Follow the on-screen instructions.
- 5 On the screen for selecting the printer connection, select “Local Printer”.

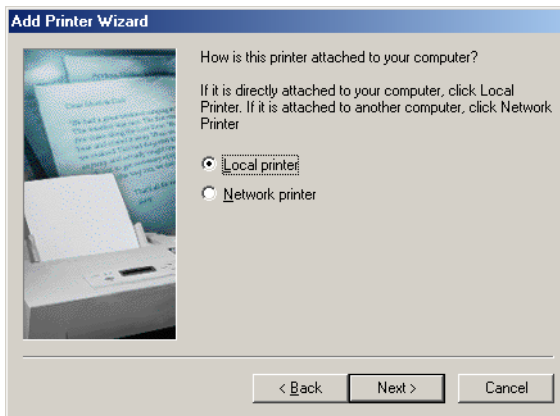

- 6 Click the [Next] button.
- 7 Click the [Have Disk] button.
- 8 Click the [Browse] button.



- 9 Specify the directory on the CD-ROM that contains the printer driver for the operating system that you are using, and then click the [OK] button.
  - For Windows 98SE/Me
    - Konica Minolta PCL driver: User Software CD-ROM  
“Driver\bizhubC252\_C252P” folder
    - PostScript PPD driver: PostScript Printer Driver CD-ROM  
“Driver\PS-PPD” folder
  - For Windows 2000
    - Konica Minolta PCL driver: User Software CD-ROM  
“Driver\bizhubC252\_C252P” folder
    - Konica Minolta PostScript driver: PostScript Printer Driver CD-ROM  
“Driver\bizhubC252” folder
  - For Windows NT 4.0
    - Konica Minolta PCL driver: User Software CD-ROM  
“Driver\bizhubC252\_C252P” folder
    - Konica Minolta PostScript driver: PostScript Printer Driver CD-ROM  
“Driver\bizhubC252” folder

**10** Click the [OK] button.

The “Printers” list appears.

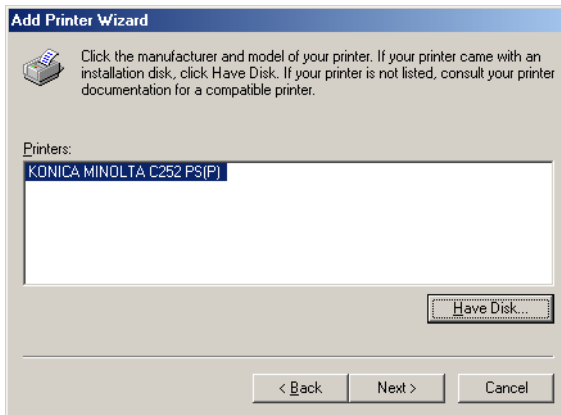

**11** Click the [Next] button.

**12** Specify the connection port. Select “LPT1” here.

**13** Follow the on-screen instructions.

- When using a network connection, perform a test print after the network settings have been specified.

- 14 When installation is complete, make sure that the icon of the installed printer appears in the Printers window.
- 15 Remove the CD-ROM from the CD-ROM drive.  
This completes the printer driver installation.

### Installing the Printer Driver Using Plug and Play

#### For Windows 98SE

- 1 After using a parallel cable or a USB cable to connect this machine to a computer, turn on the computer.
  - Do not disconnect or connect the cable while the computer is starting up.
- 2 Insert the Windows printer driver CD-ROM into the computer's CD-ROM drive.
  - Konica Minolta PCL Driver: User Software CD-ROM
  - Konica Minolta PostScript Driver: PostScript Printer Driver CD-ROM
- 3 Turn the main power of this machine on.  
The Add New Hardware Wizard starts up.
- 4 Click the [Next] button.
- 5 Select "Search for the best driver for your device (Recommended)", and then click the [Next] button.
- 6 Select "Specify a location", and then click the [Browse] button.
- 7 Specify the folder on the CD-ROM that contains the printer driver for the operating system that you are using, and then click the [OK] button.
  - Konica Minolta PCL Driver: User Software CD-ROM  
"Driver\bizhubC252\_C252P" folder
  - PostScript PPD driver: PostScript Printer Driver CD-ROM  
"Driver\PS-PPD" folder
- 8 Click the [Next] button, and then follow the on-screen instructions. If using a parallel connection, proceed to step 10.
- 9 The Add New Hardware Wizard dialog box appears again. Repeat steps 4 through 8.

- 10 When installation is complete, make sure that the icon of the installed printer appears in the Printers window.
- 11 Remove the CD-ROM from the CD-ROM drive.  
This completes the printer driver installation.

### For Windows Me/2000

- 1 After using a parallel cable or a USB cable to connect this machine to a computer, turn on the computer.
  - Do not disconnect or connect the cable while the computer is starting up.
- 2 Insert the Windows printer driver CD-ROM into the computer's CD-ROM drive.
  - Konica Minolta PCL Driver: User Software CD-ROM
  - Konica Minolta PostScript Driver: PostScript Printer Driver CD-ROM
- 3 Turn the main power of this machine on.
  - For Windows Me  
The Add New Hardware Wizard starts up.
  - For Windows 2000  
The Found New Hardware Wizard starts up.
- 4 Select "Search for a suitable driver for my device (recommended)" (for Windows Me, select "Automatic search for a better driver (Recommended)"), and then click the [Next] button.
- 5 For Windows 2000, select "Specify a location", and then click the [Next] button.  
For Windows Me, select "Specify a Location", and then click the [Browse] button.
- 6 Specify the folder on the CD-ROM that contains the printer driver for the operating system that you are using, and then click the [OK] button.  
Printer drivers that can be selected:
  - For Windows Me  
Konica Minolta PCL driver: User Software CD-ROM  
"Driver\bizhubC252\_C252P" folder  
Postscript PPD: PostScript Printer Driver CD-ROM  
"Driver\PS-PPD" folder

- For Windows 2000  
Konica Minolta PCL driver: User Software CD-ROM  
“Driver\bizhubC252\_C252P” folder  
Konica Minolta PostScript driver: PostScript Printer Driver CD-ROM  
“Driver\bizhubC252” folder

- 7 Click the [OK] button (for Windows Me, click the [Next] button), and then follow the on-screen instructions.
- 8 Click the [Finish] button.
- 9 When installation is complete, make sure that the icon of the installed printer appears in the Printers window.
- 10 Remove the CD-ROM from the CD-ROM drive.  
This completes the printer driver installation.

### **For Windows XP/Server 2003**

- 1 After using a parallel cable or a USB cable to connect this machine to a computer, turn on the computer.
  - Do not disconnect or connect the cable while the computer is starting up.
- 2 Insert the Windows printer driver CD-ROM into the computer’s CD-ROM drive.
  - Konica Minolta PCL Driver: User Software CD-ROM
  - Konica Minolta PostScript Driver: PostScript Printer Driver CD-ROM
- 3 Turn the main power of this machine on.  
The Found New Hardware Wizard starts up.  
If the Add New Hardware Wizard does not appear, turn the power of this machine off, then on again.  
When turning the power off, then on again, be sure to turn the sub-power switch off first, then the main power switch. In addition, wait at least 10 seconds before turning the power on again; otherwise, this machine may not function properly.
- 4 Select “Install from a list or specific location (Advanced)”, and then click the [Next] button.
- 5 Under “Search for the best driver in these locations”, select “Include this location in the search”, and then click the [Browse] button.

- 6 Depending on the operating system and printer driver that you are using, specify the folder on the CD-ROM that contains the printer driver, and then click the [OK] button.
  - Konica Minolta PCL driver: User Software CD-ROM “Driver\bizhubC252\_C252P” folder
  - Konica Minolta PostScript driver: PostScript Printer Driver CD-ROM “Driver\bizhubC252” folder
- 7 Click the [Next] button, and then follow the on-screen instructions.
  - When the Digital Signature dialog box appears, click the [Continue] button.
- 8 Click the [Finish] button.
- 9 When installation is complete, make sure that the icon of the installed printer appears in the Printers and Faxes window.
- 10 Remove the CD-ROM from the CD-ROM drive.

This completes the printer driver installation.

### Uninstalling the Printer Driver

If it becomes necessary to delete the printer driver, for example, when you want to reinstall the printer driver, follow the procedure below to delete the driver.

- 1 For Windows 98SE/Me/2000/NT 4.0, click the [Start] button, point to “Settings”, and then click “Printers”.  
For Windows XP/Server 2003, click the [Start] button, and then click “Printers and Faxes”.
  - If “Printers and Faxes” does not appear in the Start menu, open the Control Panel from the Start menu, select “Printers and Other Hardware”, and then select “Printers and Faxes”.
- 2 In the Printers window (for Windows XP/Server 2003, Printers and Faxes window), select the icon of the printer that you want to delete.
- 3 Press the [Delete] key on the computer keyboard to delete the printer driver.

- 4 Follow the on-screen instructions.  
When the printer driver has been deleted, the printer icon will disappear from the Printers window (for Windows XP/Server 2003, Printers and Faxes window).  
For Windows 98 Second Edition/Me/NT 4.0, this completes the uninstallation procedure.  
For Windows 2000/XP/Sever 2003, delete the driver from the server properties.
- 5 Click the “File” menu, and then click “Server Properties”.
- 6 Click the Driver tab.
- 7 Select the printer driver to be deleted from the Installed Printer Drivers list, and then click [Delete].
- 8 On the Deletion Confirmation dialog box, click the [Yes] button.
- 9 Close the Print Server Properties dialog box and Printers window (for Windows XP/Server 2003, “Printers and Faxes” window).
- 10 Restart the computer.  
This completes the uninstallation procedure.

**Note**

*Even if the printer driver is deleted using the method described above, the model information file will remain in the computer. Therefore, the driver may not be able to be overwritten when reinstalling the same version of the printer driver. When installing the same version of the printer driver, be sure to also delete the files described below.*

*Check the “C:\WINDOWS\system32\spool\drivers\w32x86” folder and delete the folder of the corresponding model if it is available. If the Konica Minolta PCL driver and Konica Minolta PostScript driver are both installed, the model information of both drivers is deleted. If one driver is remaining, do not delete it.*

*Delete the “oem\*.inf” and “oem\*.PNF” files in the “C:\WINDOWS\inf” folder. (The asterisk (\*) in the file name displays a number, and the number varies according to the environment of the computer.) Before deleting the files, open the INF file, check that the model name is described in the last several lines, and then check that the file of the corresponding model is available.*

*The PNF file is the same number as the INF file.*

## 2.3 When Used With Macintosh

The installation procedure for the Macintosh printer driver differs depending on the Mac OS version and printer driver being used. Refer to the table below for the appropriate procedure for installing the printer driver on your Macintosh computer.

Mac OS	Printer Driver	Refer to
Mac OS X 10.2, Mac OS X 10.3, and Mac OS X 10.4	PostScript PPD	“Installing the Printer Driver” on page 2-16
Mac OS 9.2 or later	PostScript PPD	“Selecting a Printer” on page 2-18

### Installing the Printer Driver

#### For Mac OS X

- 1 Turn the Macintosh computer on.
- 2 Insert the Macintosh printer driver CD-ROM into the Macintosh computer’s CD-ROM drive.
  - Quit all running applications that may have started when the Macintosh computer was turned on.
- 3 Open the “OS10\_2\_X” or “OS10\_3\_X” folder from “English”—“Driver” on the CD-ROM.
- 4 Select the Mac OS version being used, and then copy the drive file onto the desktop.
  - Mac OS X 10.2: KONICAMINOLTA\_C252\_102.pkg
  - Mac OS X 10.3: KONICAMINOLTA\_C252\_103.pkg
  - Mac OS X 10.4: KONICAMINOLTA\_C252\_103.pkg
- 5 Double-click the file copied onto the desktop.
  - Enter the requested administrator’s name and password.
  - For the administrator’s name and password, ask your network administrator.
  - To quit the installation, click the [Cancel] button.
- 6 Click the [Continue] button and follow the on-screen instructions until the Installation dialog box appears.

- 7 On the Installation dialog box, click the [Install] button.
  - From the second time the printer driver is installed and thereafter, the [Install] button may appear as the [Upgrade] button.

The printer driver is installed onto the Macintosh computer. When installation is complete, a message appears.

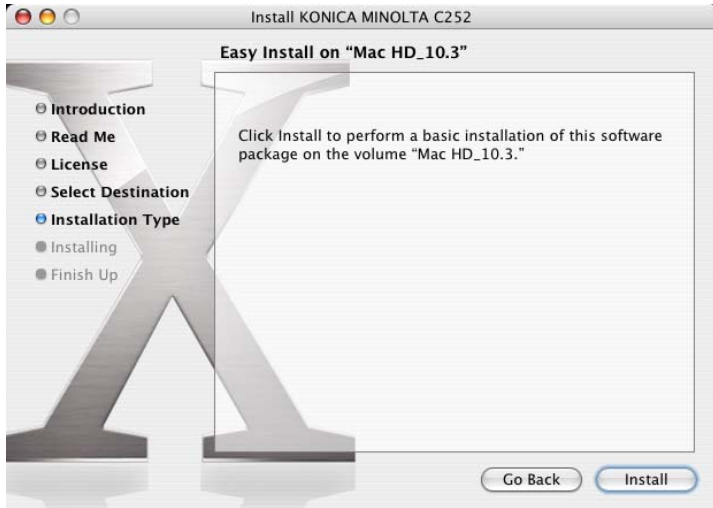

- 8 Click the [Close] button.

This completes the printer driver installation.  
Next, select the printer.



## Selecting a Printer



### Note

*If connecting using AppleTalk, the AppleTalk settings on this machine must be specified. For specifying the AppleTalk settings, refer to “Printing With Macintosh” on the User’s Guide [Print Operations].*

*If connecting using Bonjour with Mac OS X 10.4, the Bonjour settings must be specified on this machine. For specifying the Bonjour settings, refer to “Printing With Macintosh” on the User’s Guide [Print Operations].*

*If connecting using Rendezvous with Mac OS X 10.3, the Bonjour settings must be specified on this machine. For specifying the Bonjour settings, refer to “Printing With Macintosh” on the User’s Guide [Print Operations].*

### For Mac OS X

After connecting this machine to a Macintosh computer, it can be used as a printer by selecting it in Print Center or the Printer Setup Utility as the printer to be used.

- 1 Open Print Center or Printer Setup Utility, located in “Applications”—“Utilities” of “Hard Disk”.
- 2 When the Add Printer dialog box appears, click the [Add] button. When the printer list appears, click the [Add] button.
  - For Mac OS X 10.4, proceed to step 3.
  - For Mac OS X 10.2 and Mac OS X 10.3, proceed to step 4.
  - If usable printers have already been set up, the Add Printer dialog box does not appear.
- 3 If this machine appears as a printer of a Bonjour connection, select “KONICA MINOLTA” from the “Print Using” drop-down list, select “KONICA MINOLTA C252 PS(P)” in the model list, and then click the [Add] button.
  - If the selected printer is registered in the printer list, this completes the setting procedure.

- When connecting with AppleTalk and this machine does not appear as a printer, click the [More Printers] button, and then proceed to step 4.

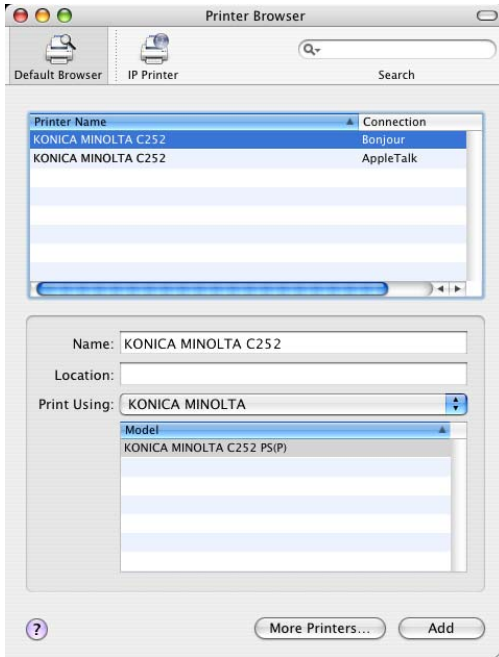

- 4 Select the applicable connection method and printer name.
  - To specify an AppleTalk zone for an AppleTalk connection, select “Local AppleTalk Zone”.
  - When “IPP” is selected as the protocol in IP Printer, the text box for entering the queue name appears.  
For Mac OS 10.3, leave the queue name text box empty.  
For Mac OS 10.4, enter “ipp” in the queue name text box.
- 5 Select “KONICA MINOLTA” from the “Printer Model” drop-down list.

- 6 Select “KONICA MINOLTA C252 PS(P)”, and then click the [Add] button.

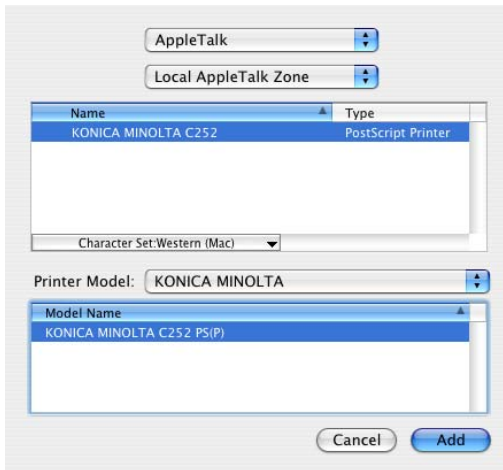

- The selected printer is registered in the printer list.

**For Mac OS 9.2**

After connecting this machine, it can be used as a printer by selecting “PostScript printer” under “Chooser” and by specifying the printer description (PPD) file.

First, copy the printer description (PPD) file onto the Macintosh computer.

- 1** Insert the Macintosh printer driver CD-ROM into the Macintosh computer’s CD-ROM drive.
- 2** Open the “OS 9\_x” folder in “English”—“Driver” on the CD-ROM.
- 3** Select PPD file “KONICAMINOLTAC252UVxxx.ppd”, and then copy it into the “Printer Descriptions” folder in “System Folder”—“Extensions” of “Hard Disk”.
  - Next, select a printer.  
The printer driver can use a standard Macintosh LaserWriter.
- 4** On the Apple menu, click “Chooser”.
- 5** Make sure that “AppleTalk” is set to “Active”, and then click the “LaserWriter” icon.
- 6** From the “Select a PostScript Printer” list, click the applicable printer for the printing system, and then click the [Create] button.
  - If a different PPD file has already been selected, click the [Setup] button, and then click the [Select PPD] button from the screen that is already displayed.

The PostScript printer description (PPD) file selection screen appears.

- 7 Select the applicable PPD file, and then click the [Select] button or the [Open] button.

The setting screen for adding Options appears.

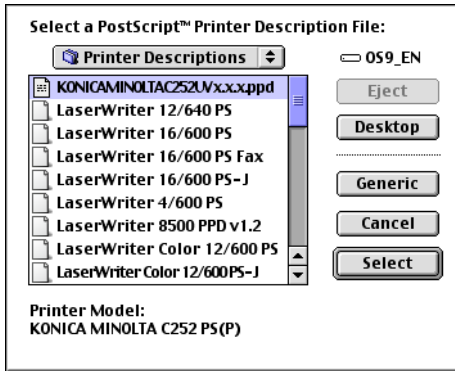

- 8 Select the option that is installed on this machine from Options Installed 1 and Options Installed 2.

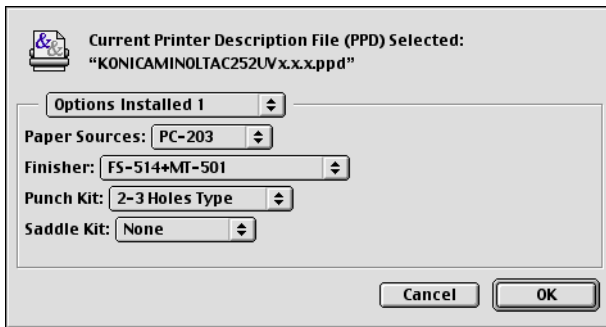

- 9 Click the [OK] button.  
The Chooser window appears again.
- 10 Close the Chooser window.

## Uninstalling the Printer Driver

If it becomes necessary to delete the printer driver, for example, when you want to reinstall the printer driver, follow the procedure below to delete the driver.



### Note

*Quit all running applications that may have started when the Macintosh computer was turned on.*

### For Mac OS X

- 1 Open Print Center or Printer Setup Utility, located in “Applications” – “Utilities” of “Hard Disk”.
- 2 Select the name of the printer to be deleted, and then click the [Delete] button.  
The selected printer is deleted.
- 3 Close the printer list.
- 4 Drag the following file, which is located in “Library” – “Printers” – “PPDs” – “Contents” – “Resources” – “en.lproj” of “Hard Disk”, to the “Trash” icon.
  - “KONICA MINOLTA C252.gz”
- 5 Delete the unnecessary files from “Library” – “Printers”.
- 6 For Mac OS 10.3 and Mac OS 10.4, drag the “\*\*\*c252” file, which is located in “Library” – “Printers” – “KONICAMINOLTA” – “filter”, and the following files, which are located in “Library” – “Printers” – “KONICAMINOLTA” – “PDEs”, to the “Trash” icon.
  - KONICAMINOLTAC252 Finishing.plugin
  - KONICAMINOLTAC252 ImageLayout.plugin
  - KONICAMINOLTAC252 Security.plugin
  - KONICAMINOLTAC252 Setup.plugin
- 7 For Mac OS 10.2, drag the following files, which are located in “Library” – “Printers” – “PPD Plugins”, to the “Trash” icon.
  - KONICAMINOLTAC252 Finishing.plugin
  - KONICAMINOLTAC252 ImageLayout.plugin
  - KONICAMINOLTAC252 Security.plugin
  - KONICAMINOLTAC252 Setup.plugin

Enter “/usr” in “Go”-“Go to Folder” to move to the “/usr” folder, and then drag the “pstokmc252” folder, which is located in “libexec”-“cups”-“filter”, to the “Trash” icon.

- 8 Restart the Macintosh computer.

This completes the uninstallation procedure.

### **For Mac OS 9.2**

- 1 Drag PPD file “KONICAMINOLTAC252UVxxx.ppd”, which is located in “System Folder”-“Extensions”-“Printer Descriptions” of “Hard Disk”, to the “Trash” icon.

The related printer driver files are deleted.

- 2 Restart the Macintosh computer.

This completes the uninstallation procedure.

## 3 Setting Up Network Printing

### 3.1 Overview of Network Functions

#### Network Functions

By connecting this machine to a network through the Ethernet port, this printing system can be used as a network printer.

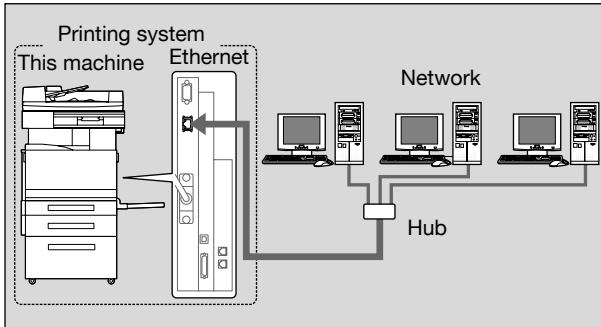

This printing system supports 10Base-T and 100Base-TX standards. In addition, the Ethernet interface supports the TCP/IP (LDP/LPR, IPP, SMB), Net-BEUI (SMB), IPX/SPX (NetWare), and AppleTalk (EtherTalk) protocols.



#### Note

*When setting up the network, the administrator password is required to enter Administrator mode.*

*Ask the administrator of this machine for the administrator password.*



## Features of the Network Functions

This printing system is equipped with the following network functions to flexibly support various network environments.

- Automatic selection of 10Base-T or 100Base-TX (Fast Ethernet)
- Obtains the IP address automatically from DHCP or BOOTP
- Printing with SMB printing (Windows 98SE/Me/2000/XP/Server 2003)  
You can print in Windows 98SE, Windows Me, Windows 2000, Windows XP, or Windows Server 2003 using SMB.
- Printing with LPR printing (Windows NT 4.0/2000/XP/Server 2003)  
You can print with LPD/LPR using Windows NT 4.0, Windows 2000, Windows XP, or Windows Server 2003. Windows 98SE and Windows Me cannot be used.

LPR (Line Printer Request): This print request system can be used under Windows NT 4.0, Windows 2000, Windows XP, or Windows Server 2003. Enter the queue name as [Print].

- Printing with Port 9100 (Windows 98SE/Me/2000/XP/Server 2003)  
You can print (Raw print) using Port 9100 under Windows 98 Second Edition, Windows Me, Windows 2000, Windows XP, or Windows Server 2003.

When using a Port 9100 connection under Windows 98 Second Edition or Windows Me, it may be necessary to install the Peer to Peer Printing Tool.

To obtain the Peer to Peer Printing Tool, consult the dealer where you purchased this machine.

- Supports Novell NetWare Pserver and Rprinter (Nprinter)
- Supports the Novell NetWare print server functions and supports both bindery mode and Novell Directory Service (NDS)

With NetWare

The Novell NetWare 4.x–6 print server functions are supported.

You can connect this printing system to a network using Novell NetWare 4.x–6 as the network operating system and send print jobs from the client to the print server (network controller). The three modes supported are as follows:

- Nprinter
- Pserver
- NDS/NDPS



### Note

*For details on the NetWare functions, refer to the NetWare operation manual.*

### With Macintosh

You can print from your Macintosh computer using LPR, AppleTalk, or Bonjour/Rendezvous.

You can connect this printing system to a print server in an AppleTalk or a Bonjour/Rendezvous environment and send print jobs from the Macintosh computer to this machine.

### Network Connection Methods That Can Be Selected in Each Windows Operating System

This chapter describes the settings that must be specified for network printing.

Setting procedures differ depending on the method of networking printing used (SMB, LPR, or IPP printing). Select the best method of network printing for your Windows environment.

### Network Printing from a Windows Operating System

	Protocol used	Windows 98 Second Edition	Windows Me	Windows 2000	Windows XP	Windows NT 4.0	Windows Server 2003
SMB Printing	TCP/IP, NetBEUI	○	○	○	○		○
LPR Printing	TCP/IP			○	○	○	○
IPP Printing	TCP/IP			○	○		○
Port 9100 Printing	TCP/IP	▲*	▲*	○	○		○

\* When using Port 9100 printing under Windows 98 Second Edition or Windows Me, the Peer to Peer Printing Tool must be installed. For the details, refer to the table below.

Conditions when the Peer to Peer Printing Tool must be installed while using Port 9100

	Operating System			
	Windows 98SE/Me		Windows 2000/XP/2003	
Driver type	Using installer	Not using installer	Using installer	Not using installer
Konica Minolta PCL	Not required <sup>*1</sup>	Required	Not required <sup>*4</sup>	
Konica Minolta PostScript	- <sup>*2</sup>			
PostScript PPD	- <sup>*3</sup>	Required	- <sup>*2</sup>	

\*1 If the printer driver is installed using the installer while this machine is connected to the network, the required Peer to Peer Printing Tool is also installed automatically, and Port 9100 is created.

\*2 The printer driver is not compatible with the operating system.

\*3 Installing the printer driver using the installer is not applicable.

\*4 Not required since standard operating system functions are used.

To obtain the Peer to Peer Printing Tool, consult the dealer where you purchased this machine.

To specify the driver settings when installing the Peer to Peer Printing Tool, refer to “Port 9100 Printing (Windows 98SE/Me/2000/XP/Server 2003)” on the User’s Guide [Print Operations].

When using SMB printing, you can perform network printing without installing the Peer to Peer Printing Tool software. For details, refer to “SMB printing” on the User’s Guide [Print Operations].



#### Reminder

*Before setting up network printing, install the printer driver. For details on installing the printer driver, refer to “Installing the Printer Driver” on page 2-1.*

*To perform network printing, change the printer port for the installed printer driver to one for a network connection, and then change the settings on this machine as necessary. For an IPP connection, it is necessary to install the printer driver first.*

### Network Printing in a NetWare Environment

NetWare version	Protocol used	Emulation	Service mode
NetWare 4.x	IPX	NDS/Bindery	Pserver/Nprinter
NetWare 5.x/6	IPX	NDS	Pserver
	TCP/IP	NDPS(lpr)	

## 3.2 Accessing PageScope Web Connection

Setting the IP address for this machine enables you to access PageScope Web Connection.

Use your Web browser to directly access PageScope Web Connection.

### To access PageScope Web Connection

- 1 Start up the Web browser.
- 2 In the “Address” bar, enter the IP address for this machine as shown below, and then press the [Enter] key.
  - `http://<IP_address_for_this_machine>/`  
Example: If the IP address for this machine is 192.168.1.20  
`http://192.168.1.20/`

The initial page of PageScope Web Connection appears.

For further details on PageScope Web Connection, refer to “Using PageScope Web Connection” on the User’s Guide [Print Operations].



#### **Note**

*If the user authentication function is enabled, you must enter a user name and password.*



## 4 Various Printing Methods

### 4.1 Printing Operations

#### For Windows

Data can be printed from an application.

Print jobs are specified from the application software.

- 1 Open the data in the application, “File”, and then click “Print”.
- 2 Check that the printer name has been selected in “Printer Name” or “Select Printer”.
  - If the printer is not selected, click to select the printer.

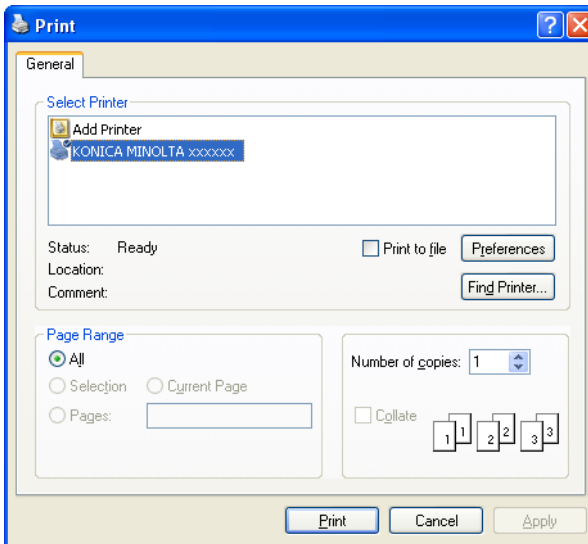

- 3 Specify the page range and the number of copies to print.
  - The Print dialog box differs depending on the application.

- 4 Click the [Preferences] button or the [Properties] button to change the printer driver settings as necessary.
  - By clicking the [Preferences] button or the [Properties] button on the Print dialog box, you can specify the settings of each model on the printer driver dialog box that appears. For details, refer to “Setting Up the PCL Driver” on the User’s Guide [Print Operations], “Setting Up the PostScript Driver (Windows)” on the User’s Guide [Print Operations] or “Setting Up the PPD Driver (Windows)” on the User’s Guide [Print Operations].  
If the changed settings are not saved in the Print dialog box, the original settings are restored when the application is quit.
- 5 Click the [Print] button.  
The Data indicator of this machine flashes.

### PCL Driver

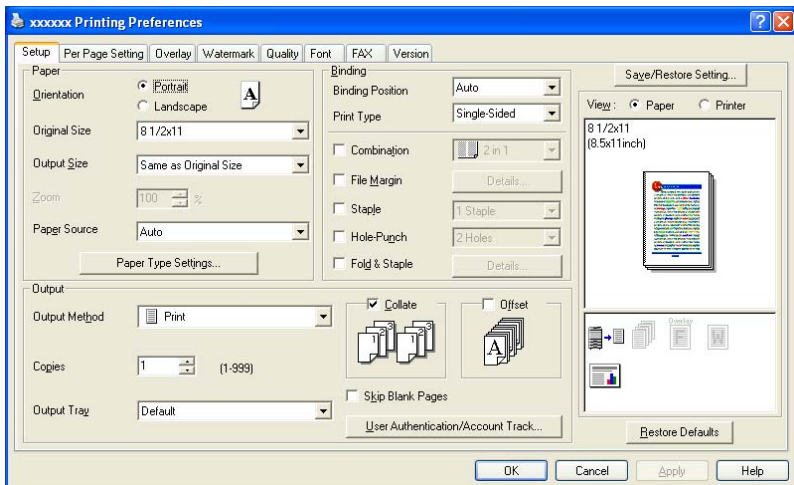

PostScript Driver

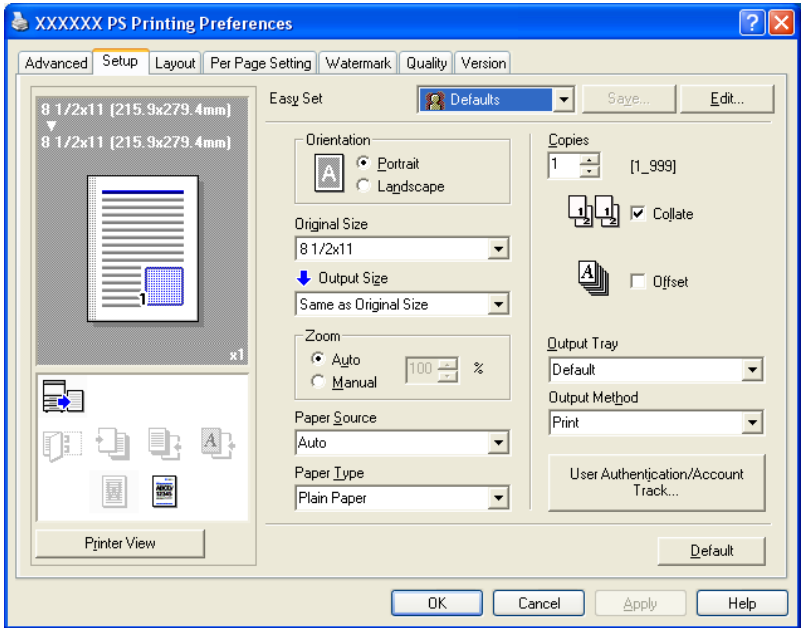

PostScript PPD Driver

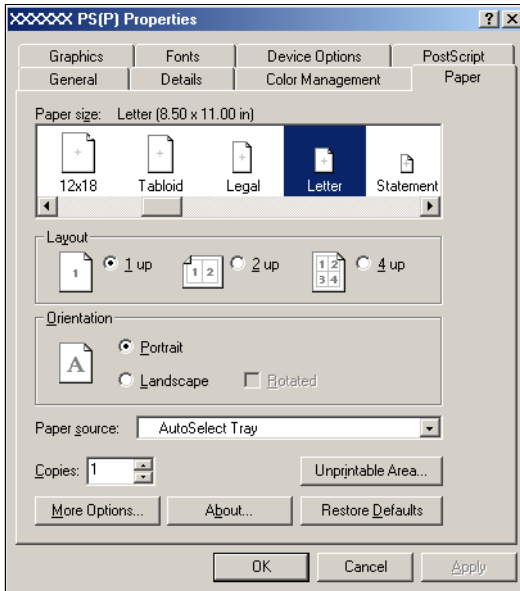



## Test Printing

Printing is possible when the printer driver is installed and the network settings have been specified. To check that connection has been made properly, you can print the standard Windows test page.

Print a test page from the printer driver Properties dialog box.

- 1 For Windows 98SE/Me/2000/NT 4.0, click the [Start] button, point to “Settings”, and then click “Printers”.  
For Windows XP/Server 2003, click the [Start] button, and then click “Printers and Faxes”.
  - If “Printers and Faxes” does not appear in the Start menu, open the Control Panel from the Start menu, select “Printers and Other Hardware”, and then select “Printers and Faxes”.
- 2 Right-click the icon of the installed printer, and then click “Properties”.
- 3 Click the General tab, and then click the [Print Test Page] button or the [Print Test] button.  
The test page is printed and the confirmation dialog box appears.
- 4 Check the printout, and then click the [OK] button or the [Yes] button.



### Note

*If the test page is not printed properly, check that the printer driver has been installed properly and that the network settings are complete.*

## For Macintosh

Printing is possible when the printer driver is installed and the network settings have been specified. Print jobs are specified from the application software.

The functions of this machine that can be used when printing can be specified in the Print dialog box or the Page Setup dialog box.

The settings can only be applied while using the application. When the application is exited, the settings return to their default settings.

## For Mac OS X

- 1 Open the data in the application, “File”, and then click “Print”.
- 2 Check that the printer name has been selected.

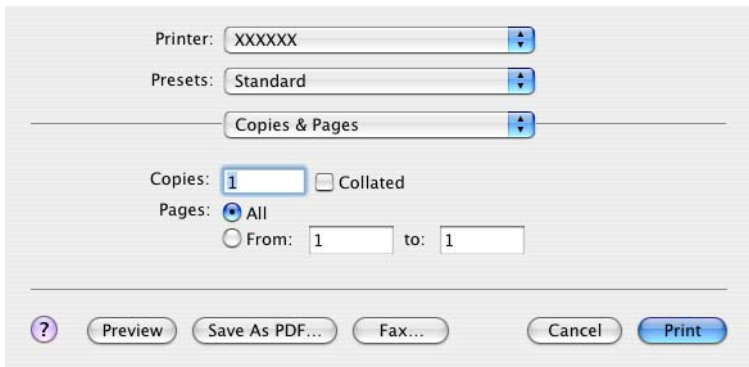

- 3 Specify the print range and the number of copies to print, and then click the [Print] button.

The Data indicator of this machine flashes.



### Note

*If the printer name does not appear in the list, select the printer in Print Center or the Printer Setup Utility. For details, refer to “Selecting a Printer” on page 2-18.*

*The Print dialog box differs depending on the application.*

**For Mac OS 9.2**

- 1 Open the data in the application, “File”, and then click “Print”.
- 2 Check that the printer name has been selected.
- 3 Select “General”.

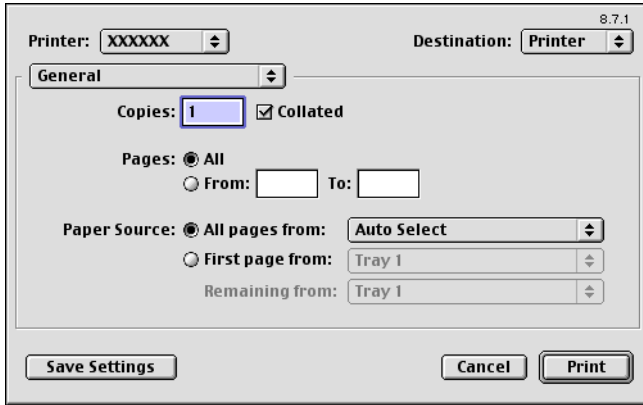

- 4 Specify the Pages and the number of copies to print, and then click the [Print] button.

The Data indicator of this machine flashes.

**Note**

*If the printer name does not appear in the list, select the printer from the Chooser window. For details, refer to “Selecting a Printer” on page 2-18.*

*The Print dialog box differs depending on the application.*

*The settings can be saved by clicking the [Save Settings] button.*

## 4.2 Setting the Printing Functions

The functions of this machine such as sorting and folding can be set when printing from a computer. Depending on the operating system running on the connected computer, the setting procedure of this machine's functions may differ.

### Function List

The function list contains a summary of the main settings related to printing and printer driver support.



#### Note

*The function names in this list are based on those displayed by the PCL printer driver in Windows XP. In addition, the items and setting values displayed may differ depending on whether the options are installed or the settings are available.*

Function	Overview	Printer Driver		
		PCL	Post Script	PPD
Orientation	Selects the original document paper orientation.	<input type="radio"/>	<input type="radio"/>	<input type="radio"/>
Original Size	Specifies the size of the original document.	<input type="radio"/>	<input type="radio"/>	
Output Size	Specifies the output paper size.	<input type="radio"/>	<input type="radio"/>	<input type="radio"/>
Zoom	Prints enlarged or reduced.	<input type="radio"/>	<input type="radio"/>	<input type="radio"/>
Paper Source	Selects the paper source for printing.	<input type="radio"/>	<input type="radio"/>	<input type="radio"/>
Paper Type Settings	Specifies the paper type of the paper source.	<input type="radio"/>	<input type="radio"/>	<input type="radio"/>
Binding Position	Selects the binding position.	<input type="radio"/>	<input type="radio"/>	<input type="radio"/>
Print Type	Selects the print type (simplex, duplex, or booklet).	<input type="radio"/>	<input type="radio"/>	<input type="radio"/>
Combination	Prints multiple pages on one page.	<input type="radio"/>	<input type="radio"/>	<input type="radio"/>
File Margin	Sets Margins for punch holes and staples.	<input type="radio"/>		
Staple	Staples documents.	<input type="radio"/>	<input type="radio"/>	<input type="radio"/>
Hole-Punch	Punches holes in documents.	<input type="radio"/>	<input type="radio"/>	<input type="radio"/>
Center Staple and Fold	Center staples printed documents.	<input type="radio"/>	<input type="radio"/>	<input type="radio"/>
Output Method (Job Management)	For non-conventional printing, selects the special output format for secured documents or saves data in a box.	<input type="radio"/>	<input type="radio"/>	(Mac OS X only)
Copies	Specifies the number of copies to print.	<input type="radio"/>	<input type="radio"/>	<input type="radio"/>

Function	Overview	Printer Driver		
		PCL	Post Script	PPD
Output Tray	Selects the tray where to output the printed pages.	<input type="radio"/>	<input type="radio"/>	<input type="radio"/>
Collate	Specifies whether to print multiple copies in sets.	<input type="radio"/>	<input type="radio"/>	<input type="radio"/>
Offset	When printing multiple copies, shifts the output position of each set.	<input type="radio"/>	<input type="radio"/>	<input type="radio"/>
Skip Blank Pages	Does not print blank pages in data.	<input type="radio"/>		
Front Cover Page	Attaches a front cover page.	<input type="radio"/>	<input type="radio"/>	<input type="radio"/>
Back Cover Page	Attaches a back cover page.	<input type="radio"/>	<input type="radio"/>	<input type="radio"/>
Transparency Interleave	Inserts interleaves between overhead projector transparencies.	<input type="radio"/>	<input type="radio"/>	<input type="radio"/>
Per Page Setting	Switches the paper and trays per page.	<input type="radio"/>		
Chapter	Specifies the page to be printed on the front side.	<input type="radio"/>		
Overlay	Prints the original document on top of form data that was created separately.	<input type="radio"/>		
Watermark	Prints a watermark (text stamp) on the page being printed.	<input type="radio"/>	<input type="radio"/>	
Distribution Number Stamping	Prints the number of the copy.	<input type="radio"/>		
Copy Protect	Prints a special pattern and prevents copying.	<input type="radio"/>		
Select Color	Selects color printing and monochrome printing.	<input type="radio"/>	(No two color selection)	(No two color selection)
Original Image Type	Prints with a quality suitable for the selected original document.	<input type="radio"/>	<input type="radio"/>	<input type="radio"/>
Quality Adjustment	Adjusts the image quality.	<input type="radio"/>	<input type="radio"/>	<input type="radio"/>
Pattern	Specifies the graphic pattern details.	<input type="radio"/>		
Use Printer Fonts	Specifies the replacement of TrueType fonts with printer fonts.	<input type="radio"/>	<input type="radio"/>	<input type="radio"/>
FAX	Sends data as a fax.	<input type="radio"/>		
User Authentication/Account Track	Printing is performed after the registered user name and password are entered.	<input type="radio"/>	<input type="radio"/>	(Mac OS X only)
Account Track	Performs account track operations.	<input type="radio"/>	<input type="radio"/>	(Mac OS X only)

**Function Overview**

An overview of each function is summarized in this section.

**Orientation**

You can specify “Portrait” or “Landscape” as the orientation of the page being printed.

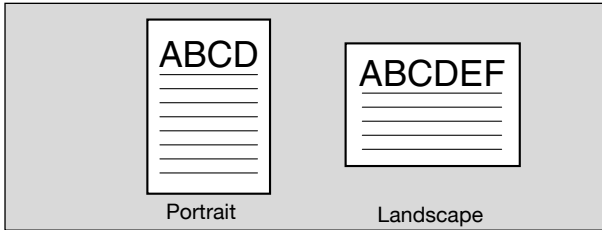

Operating System	Printer Driver	Refer to
Windows	Konica Minolta PCL	“Specifying the Setup Tab Settings” on the User’s Guide [Print Operations]
	Konica Minolta PostScript	“Specifying the Setup Tab Settings” on the User’s Guide [Print Operations]
	PostScript PPD	“Specifying the Paper Tab Settings” on the User’s Guide [Print Operations]
Mac OS X	PostScript PPD	“Page Attributes (Basic Settings)” on the User’s Guide [Print Operations]
Mac OS 9.2		“Page Attributes (Basic Settings)” on the User’s Guide [Print Operations]

## Original Size and Output Size

You can specify the original document size and the output paper size. By specifying each size, you can specify the enlargement and reduction ratio.

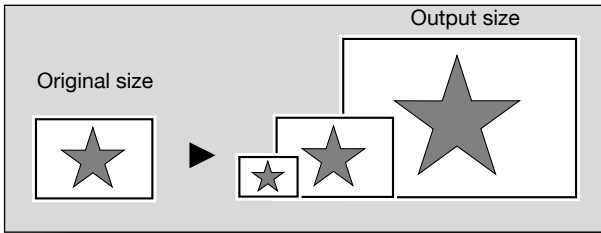

Operating System	Printer Driver	Refer to
Windows	Konica Minolta PCL	"Specifying the Setup Tab Settings" on the User's Guide [Print Operations]
	Konica Minolta PostScript	"Specifying the Setup Tab Settings" on the User's Guide [Print Operations]
	PostScript PPD	"Specifying the Paper Tab Settings" on the User's Guide [Print Operations]
Mac OS X	PostScript PPD	"Page Attributes (Basic Settings)" on the User's Guide [Print Operations]
Mac OS 9.2		"Page Attributes (Basic Settings)" on the User's Guide [Print Operations]



### Note

*Only the output paper sizes can be specified with the PostScript PPD driver for Windows and the Macintosh.*

### Zoom (Enlargement and Reduction)

You can specify the enlargement or reduction ratio using numeric values.

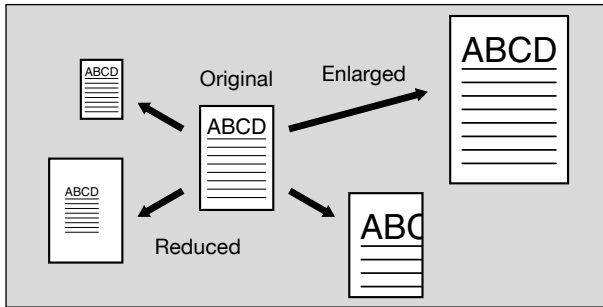

Operating System	Printer Driver	Refer to
Windows	Konica Minolta PCL	"Specifying the Setup Tab Settings" on the User's Guide [Print Operations]
	Konica Minolta PostScript	"Specifying the Setup Tab Settings" on the User's Guide [Print Operations]
	PostScript PPD	"Graphics Tab" on the User's Guide [Print Operations]
Mac OS X	PostScript PPD	"Page Attributes (Basic Settings)" on the User's Guide [Print Operations]
Mac OS 9.2		"Page Attributes (Basic Settings)" on the User's Guide [Print Operations]



## Input Tray (Paper Source)

You can select the input tray as the paper source for printing. When changing the paper type, you can select an input tray according to the paper type.

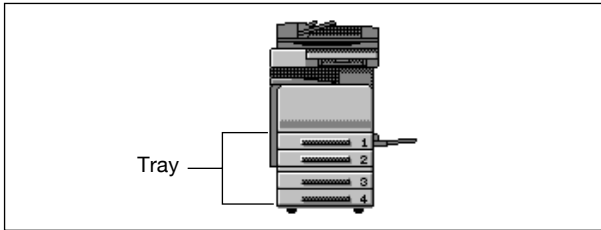

Operating System	Printer Driver	Refer to
Windows	Konica Minolta PCL	"Specifying the Setup Tab Settings" on the User's Guide [Print Operations]
	Konica Minolta PostScript	"Specifying the Setup Tab Settings" on the User's Guide [Print Operations]
	PostScript PPD	"Specifying the Paper Tab Settings" on the User's Guide [Print Operations]
Mac OS X	PostScript PPD	"Paper Feed" on the User's Guide [Print Operations]
Mac OS 9.2		"General (Basic Settings)" on the User's Guide [Print Operations]

## Paper Type

You can specify the paper type being printed.

Operating System	Printer Driver	Refer to
Windows	Konica Minolta PCL	"Specifying the Setup Tab Settings" on the User's Guide [Print Operations]
	Konica Minolta PostScript	"Specifying the Setup Tab Settings" on the User's Guide [Print Operations]
	PostScript PPD	"Specifying the Paper Tab Settings" on the User's Guide [Print Operations]



### Note

*With the Konica Minolta PCL driver for Windows, the paper type settings can be pre-set by specifying the paper type of the paper tray.*

**Print Type (Duplex Printing/Booklet Printing)**

You can print onto both sides of a page or in a booklet format (two facing pages or center binding). This comes in handy when you want to bind multiple-page documents.

The binding area can be specified by specifying the binding position.

**Duplex Printing**

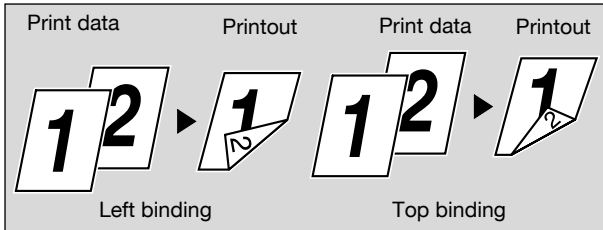

**Booklet Printing**

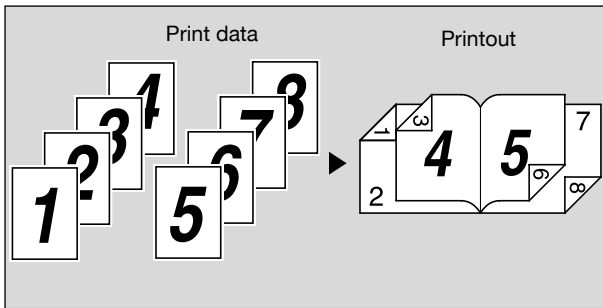

Operating System	Printer Driver	Refer to
Windows	Konica Minolta PCL	"Specifying the Setup Tab Settings" on the User's Guide [Print Operations]
	Konica Minolta PostScript	"Specifying the Layout Tab Settings" on the User's Guide [Print Operations]
	PostScript PPD	"Specifying the Device Options Tab Settings" on the User's Guide [Print Operations]
Mac OS X	PostScript PPD	"Finishing" on the User's Guide [Print Operations]
Mac OS 9.2		"Printer Specific Options (Finishing Options 1 to 4)" on the User's Guide [Print Operations]

**Note**

*The duplex printing and booklet printing functions are available only when the optional auto duplex unit is installed.*

**Printing Multiple Pages on One Page**

You can print multiple document pages on one page. This comes in handy when you want to reduce the number of output pages.

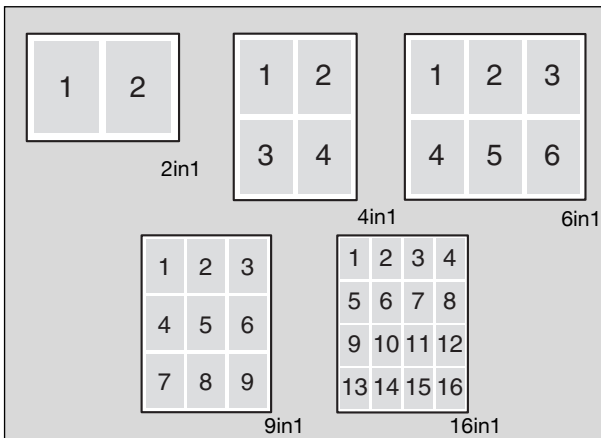

Operating System	Printer Driver	Refer to
Windows	Konica Minolta PCL	"Specifying the Setup Tab Settings" on the User's Guide [Print Operations]
	Konica Minolta PostScript	"Specifying the Layout Tab Settings" on the User's Guide [Print Operations]
	PostScript PPD	"Specifying the Layout Tab Settings" on the User's Guide [Print Operations]
Mac OS X	PostScript PPD	"Layout (Printing Multiple Pages on One Page)" on the User's Guide [Print Operations]
Mac OS 9.2		"Layout (Printing Multiple Pages on One Page)" on the User's Guide [Print Operations]

### Stapling and Hole Punching

Documents can be stapled together or holes can be punched into the document.

By specifying the file margin, you can specify the margin for stapling or hole punching.

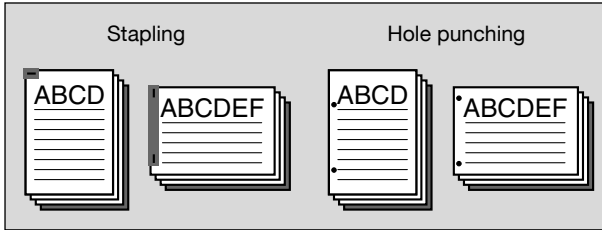

**Note**

*The staple function is available only when optional finisher FS-514, FS-501, or FS-603 is installed.*

*The hole punch function is available only when optional finisher FS-514 and punch kit PK-510 are installed, or when optional finisher FS-603 and punch kit PK-501 are installed.*

*The number of staples that can be selected may vary depending on the finisher that is installed. When optional finisher FS-501 is installed, specify "1 staple". When optional finisher FS-514 or FS-603 is installed, specify "1 staple" or "2 staples".*

Operating System	Printer Driver	Refer to
Windows	Konica Minolta PCL	"Specifying the Setup Tab Settings" on the User's Guide [Print Operations]
	Konica Minolta PostScript	"Specifying the Layout Tab Settings" on the User's Guide [Print Operations]
	PostScript PPD	"Specifying the Device Options Tab Settings" on the User's Guide [Print Operations]
Mac OS X	PostScript PPD	"Finishing" on the User's Guide [Print Operations]
Mac OS 9.2		"Printer Specific Options (Finishing Options 1 to 4)" on the User's Guide [Print Operations]

## Output Method (Job Management)

You can select “Secured Print”, which requires a password to print, or “Save in User Box”, which saves documents in a document folder.

Operating System	Printer Driver	Refer to
Windows	Konica Minolta PCL	“Specifying the Setup Tab Settings” on the User’s Guide [Print Operations]
	Konica Minolta PostScript	“Specifying the Setup Tab Settings” on the User’s Guide [Print Operations]
	PostScript PPD	“Specifying the Device Options Tab Settings” on the User’s Guide [Print Operations]
Mac OS X		“Security” on the User’s Guide [Print Operations]

## Sorting (Collating) and Classifying (Offset)

You can print the complete document sets the specified number of times or each page the specified number of times.

By specifying offset, the output position can be shifted and output to the front and back for each copy. (Multiple paper sources are used when a shifting finisher is installed and when no finisher is installed.)

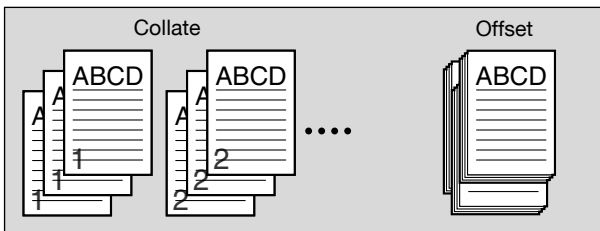

Operating System	Printer Driver	Refer to
Windows	Konica Minolta PCL	“Specifying the Setup Tab Settings” on the User’s Guide [Print Operations]
	Konica Minolta PostScript	“Specifying the Setup Tab Settings” on the User’s Guide [Print Operations]
	PostScript PPD	“Specifying the Device Options Tab Settings” on the User’s Guide [Print Operations]

Operating System	Printer Driver	Refer to
Mac OS X	PostScript PPD	“Copies & Pages (General Settings)” and “Finishing” on the User’s Guide [Print Operations]
Mac OS 9.2		“Copies & Pages (General Settings)” and “Printer Specific Options (Finishing Options 1 to 4)” on the User’s Guide [Print Operations]

**Skip Blank Pages (Saving Paper)**

Does not print blank pages in the data.

Operating System	Printer Driver	Refer to
Windows	Konica Minolta PCL	“Specifying the Setup Tab Settings” on the User’s Guide [Print Operations]

**Front Cover, Back Cover, and Transparency Interleave**

A front cover and back cover can be added and interleaves between overhead projector transparencies can be inserted.

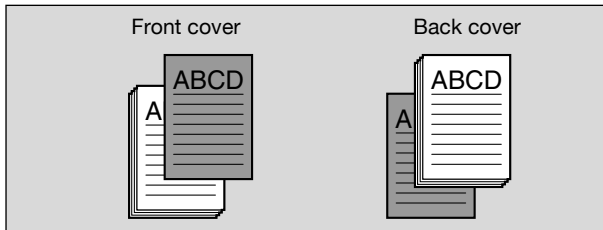

Operating System	Printer Driver	Refer to
Windows	Konica Minolta PCL	“Specifying the Per Page Setting Tab Settings” and “Specifying the Setup Tab Settings” on the User’s Guide [Print Operations]
	Konica Minolta PostScript	“Specifying the Per Page Setting Tab Settings” on the User’s Guide [Print Operations]
	PostScript PPD	“Specifying the Device Options Tab Settings” on the User’s Guide [Print Operations]

Operating System	Printer Driver	Refer to
Mac OS X	PostScript PPD	"Setup" on the User's Guide [Print Operations]
Mac OS 9.2		"Printer Specific Options (Finishing Options 1 to 4)" on the User's Guide [Print Operations]

### Per Page Setting

You can specify to have paper inserted between pages and specify simplex printing or duplex printing and the paper for printing for each page.

Operating System	Printer Driver	Refer to
Windows	Konica Minolta PCL	"Specifying the Per Page Setting Tab Settings" on the User's Guide [Print Operations]

### Chapter

You can specify the page that you want to print on the front side when duplex printing or booklet printing.

Even if a specified page comes up to be printed on the back side in duplex printing or booklet printing, the specified page is moved and printed on the front side.

Operating System	Printer Driver	Refer to
Windows	Konica Minolta PCL	"Specifying the Per Page Setting Tab Settings" on the User's Guide [Print Operations]

### Overlay

Prints the original document on top of form data that was created separately.

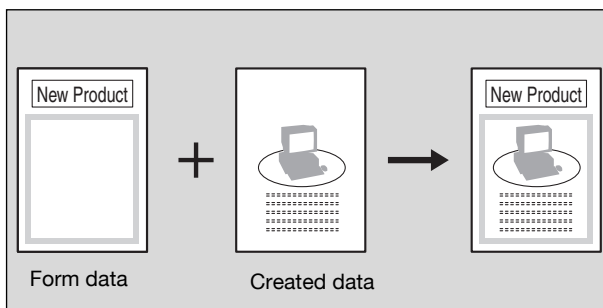

Operating System	Printer Driver	Refer to
Windows	Konica Minolta PCL	"Specifying the Overlay Tab Settings" on the User's Guide [Print Operations]

**Watermark**

Prints a watermark (text stamp) on the page being printed.

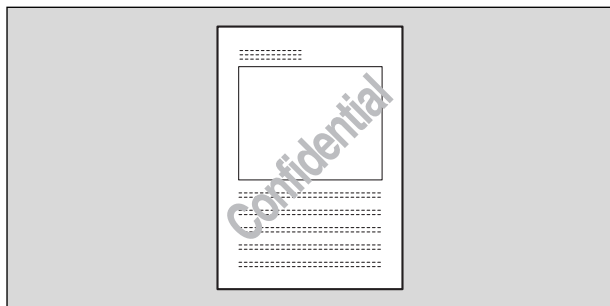

Operating System	Printer Driver	Refer to
Windows	Konica Minolta PCL	"Specifying the Watermark Tab Settings" on the User's Guide [Print Operations]
	Konica Minolta PostScript	"Specifying the Watermark Tab Settings" on the User's Guide [Print Operations]

**Copy Protect**

You can print a special pattern on an entire page while printing.

When the pattern on the printed page is copied, the characters embedded in the pattern appear to prevent an illegal copy.

Operating System	Printer Driver	Refer to
Windows	Konica Minolta PCL	"Specifying the Watermark Tab Settings" on the User's Guide [Print Operations]



## Quality Adjustment

Adjusts the image quality.

Operating System	Printer Driver	Refer to
Windows	Konica Minolta PCL	"Specifying the Quality Tab Settings" on the User's Guide [Print Operations]
	Konica Minolta PostScript	"Specifying the Quality Tab Settings" on the User's Guide [Print Operations]
	PostScript PPD	"Specifying the Device Options Tab Settings" on the User's Guide [Print Operations]
Mac OS X	PostScript PPD	"Quality" on the User's Guide [Print Operations]
Mac OS 9.2		"Printer Specific Options (Finishing Options 1 to 4)" on the User's Guide [Print Operations]

## Use Printer Fonts (Substitute Fonts)

Specifies the replacement of TrueType fonts with printer fonts.

Operating System	Printer Driver	Refer to
Windows	Konica Minolta PCL	"Specifying the Font Tab Settings" on the User's Guide [Print Operations]
	Konica Minolta PostScript	"Specifying the Quality Tab Settings" on the User's Guide [Print Operations]
	PostScript PPD	"Fonts Tab" on the User's Guide [Print Operations]
Mac OS 9.2	PostScript PPD	"PostScript Options" on the User's Guide [Print Operations]

## User Authentication

When the authentication settings have been applied on this machine, you must enter the required user name and password.

Operating System	Printer Driver	Refer to
Windows	Konica Minolta PCL	"Specifying the Setup Tab Settings" on the User's Guide [Print Operations]
	Konica Minolta PostScript	"Specifying the Setup Tab Settings" on the User's Guide [Print Operations]
Mac OS X	PostScript PPD	"Security" on the User's Guide [Print Operations]

**Account Track**

Specifies when this machine is operating in Account Track.

<b>Operating System</b>	<b>Printer Driver</b>	<b>Refer to</b>
Windows	Konica Minolta PCL	"Specifying the Setup Tab Settings" on the User's Guide [Print Operations]
	Konica Minolta PostScript	"Specifying the Setup Tab Settings" on the User's Guide [Print Operations]
Mac OS X	PostScript PPD	"Security" on the User's Guide [Print Operations]



## 5 Various Settings

### 5.1 Print Reports

You can output the following four types of reports.

Configuration Page: Outputs a list of this machine's settings.

Demo Page: Outputs a test page.

PCL Font List: Outputs the PCL font list.

PS Font List: Outputs the PS font list.

#### To Print

- 1 Press the [Utility/Counter] key.

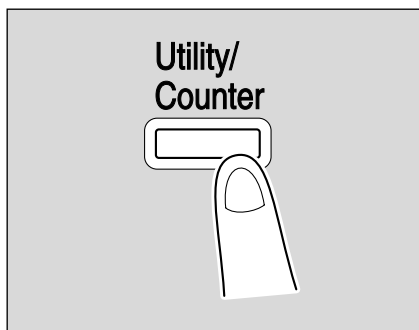

- 2 Touch [2 User Setting].

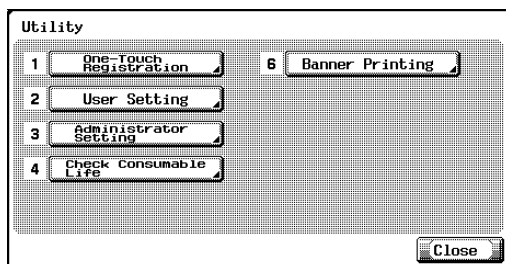

The User Setting screen appears.

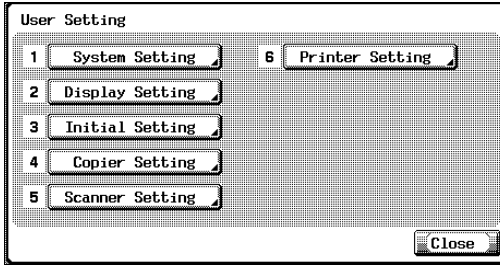

- 3 Touch [6 Printer Setting].
- 4 Touch [5 Print Reports].
- 5 Touch the button for the desired setting.

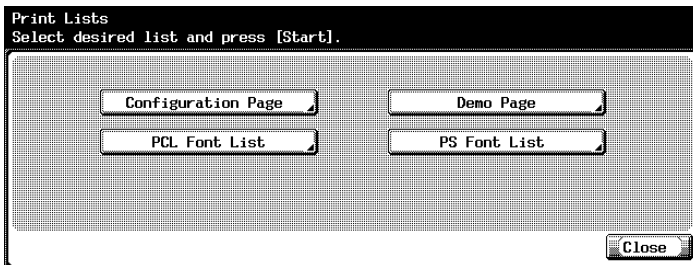

- Configuration Page: Outputs a list of this machine's settings.
- Demo Page: Outputs a test page.
- PCL Font List: Outputs the PCL font list.
- PS Font List: Outputs the PS font list.

- 6 Touch the button for the desired paper tray and the [Simplex/Duplex] button.

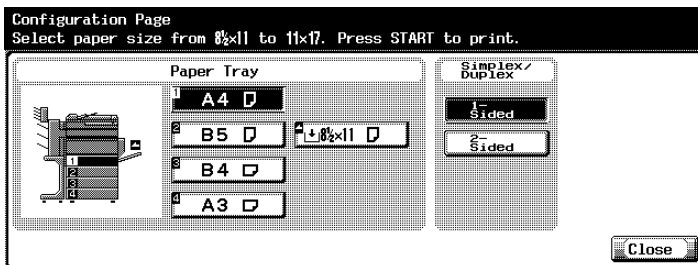

- 7 To output a report, press the [Start] key.

## 5.2 Printing on Banner Paper

Paper up to 1200 mm (47-1/4 inch) long can be loaded into the bypass tray and printed on using this machine with the appropriate setting specified from the control panel.

Loading banner paper and printing on it is referred to as “banner printing” throughout the manual.

### Paper

#### Paper types

Paper Width	Paper Length	Paper Type
210 to 297 mm (8-1/4 to 11-3/4 inch)	457.3 to 1200 mm (18 to 47-1/4 inch)	127 to 160 g/m <sup>2</sup> (33-3/4 to 42-1/2 lb)



#### Note

*Feed only one sheet of paper at a time.*

### Printer Drivers and Supported Operating Systems

The following drivers are compatible with banner paper printing.

Page Description Language	Printer Driver	Supported Operating Systems
PCL (PCL XL)	Konica Minolta PCL Driver	Windows NT 4.0, Windows 2000 Professional, Windows XP Home Edition, Windows XP Professional, and Windows Server 2003
PostScript 3 Emulation	Konica Minolta PostScript Driver	Windows NT 4.0, Windows 2000 Professional, Windows XP Home Edition, Windows XP Professional, and Windows Server 2003

### Specifying Printer Driver Settings

#### To specify printer driver settings

The paper sizes to be printed are preregistered as Custom Size.

- 1 Click the Setup tab.
- 2 From the “Original Size” or “Output Size” drop-down list, select “Custom Size Settings”.

The Custom Size Settings dialog box appears.

- 3 Specify settings for the following:
  - List of Custom Sizes: Select the size for the custom size being set. (Konica Minolta PCL driver only)
  - Custom Size Name: Input the name of the custom size being registered. (Konica Minolta PCL driver only)
  - Size: Specify the width and length of the custom size according to the selected measurement units.
- 4 Click the [OK] button.
- 5 When printing, select the Custom Size that was registered from the “Original Size” and “Output Size” drop-down lists on the Setup tab.

**Note**

*For the Konica Minolta PCL driver, the custom size settings can only be specified from the printer driver setup dialog box, which can be displayed from the Printers window (for Windows XP/Server 2003, Printers and Faxes window).*

## Printing

### To print

- 1 Press the [Utility/Counter] key in the control panel.
- 2 Touch [6 Banner Printing].
- 3 Touch [ON], and then touch [OK].

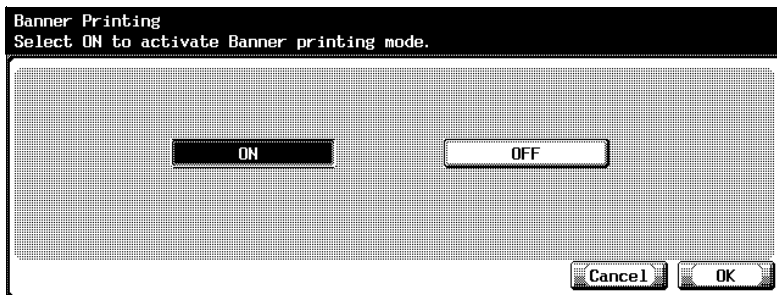

- 4 Select a job to be printed from the computer, and then click "Print" on the "File" menu.
- 5 Specify the desired settings, and then click the [OK] button.
- 6 Open the bypass tray.
- 7 With the side to be printed on facing down, insert the paper as much as possible into the feed slot.
  - Before loading the paper, check that the following message appears in the control panel.

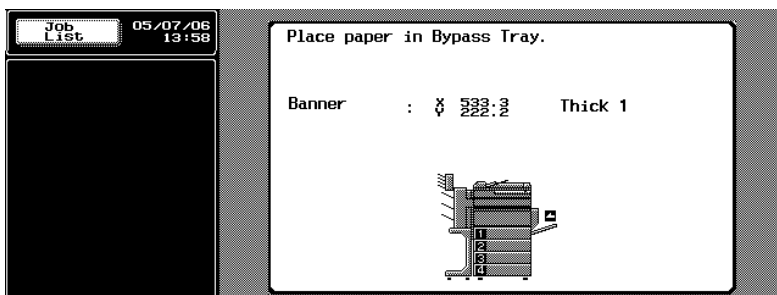



- 8 Slide the lateral guides to fit the size of paper being loaded.
- Load one sheet at a time.
  - Print while supporting the loaded paper with your hands.

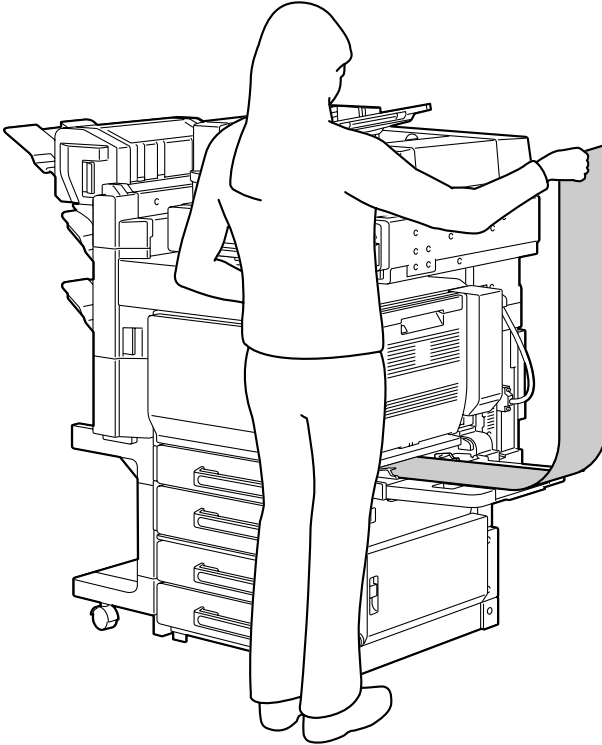

- 9 If the following screen appears, touch [Complete].

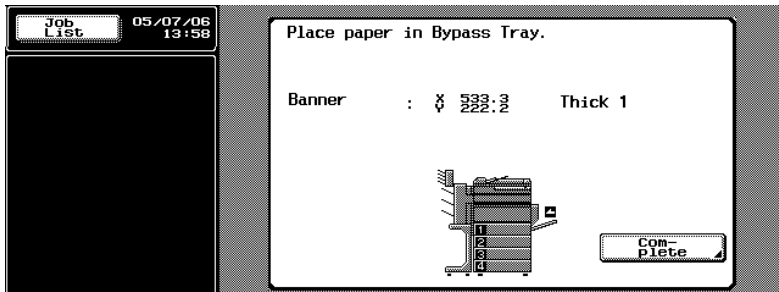

10 When printing is finished, touch [Finish].

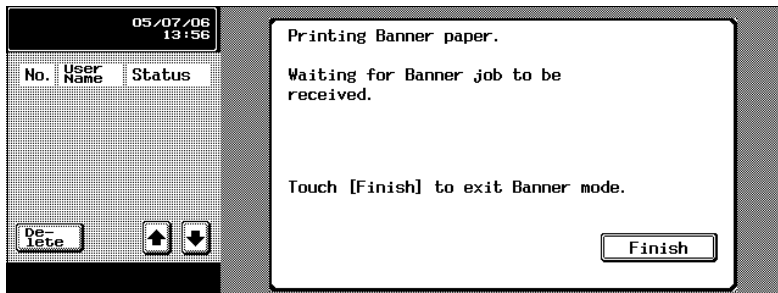

- To continue printing, repeat steps 7 through 9.

11 Touch [Yes].





# 6 Troubleshooting

## 6.1 Unable To Print

This chapter explains the troubleshooting procedures for possible malfunctions.

Perform the troubleshooting procedures described below if this machine does not print after you have sent a print job.

Symptom	Probable Cause	Action
The message "No printers are connected." or "Print error" appears.	The printer driver selected for printing is not compatible with the printer controller.	Check the printer name selected.
	The network cable, parallel cable, or USB cable is disconnected.	Check that the cable is connected properly.
	An error has occurred in this machine.	Check this machine's control panel.
	Available memory space is not sufficient.	Perform a test print to check whether printing is possible.
	The network cable, parallel cable, or USB cable is disconnected.	Check that the cable is connected properly.
	An error has occurred in this machine.	Check this machine's control panel.
A postscript error appears.	Available computer memory space is not sufficient.	Perform a test print to check whether printing is possible.
	There is an error in the application software settings.	Refer to the user's manual of the application software to check the settings.
	The file printing settings are incorrect.	Change the settings and try to print again.

Symptom	Probable Cause	Action
The machine does not start printing although the print job was completed on the computer.	The printer driver selected for printing is not compatible with the printer controller.	Check the printer name selected.
	The network cable, parallel cable, or USB cable is disconnected.	Check that the cable is connected properly.
	An error has occurred in this machine.	Check this machine's control panel.
	A print job is queued in this machine, delaying printing.	Check the job order on the Active Jobs list of the machine's control panel.
	"Save in User Box" was selected for the print job.	Check if the print job is stored on the Box screen of this machine's control panel.
	"Secure Print" was selected for the print job.	Check if the print job is held on the Secure Print User Box screen of this machine's control panel.
	If the account track settings have been applied, an unregistered department name (or password) may have been entered.	Enter the correct department name (or password).
	If the authentication settings have been applied, an unregistered user name (or password) may have been entered.	Enter the correct user name (or password).
	Available computer memory space is not sufficient.	Perform a test print to check whether printing is possible.
	The connection of this machine to the network is not yet established (while connecting to a network).	Consult with the network administrator.
	The enhanced security mode may be enabled on this machine.	Specify the authentication settings in the enhanced security mode. For details, consult with the network administrator.

If the problem persists after all of these procedures have been performed, read the User's Guide [Copy Operations].

## 6.2 Unable To Specify Desired Settings or Unable To Print as Specified

Perform these troubleshooting procedures if you cannot specify the desired settings in the printer driver, or if the print results do not represent the settings that have been specified.



**Note**

*Some of the printer driver functions cannot be combined with other functions.*

Symptom	Probable Cause	Action
A printer driver setting cannot be selected.	Some functions cannot be combined.	Do not try to select settings that are not available.
The "Conflicts" message with "Unable to Select" or "Function Canceled" appears.	An incorrect combination of functions has been specified.	Check the settings and specify the functions correctly.
Printing is not performed as specified.	Incorrect settings are specified.	Check each setting in the printer driver.
	A combination of functions, although possible in the printer driver, is not possible with this machine.	
	The paper size, orientation, and other settings specified in the application have priority over those specified in the printer driver.	Enter the correct settings in the application.
The watermark cannot be printed.	The watermark is not correctly set.	Check the watermark settings.
	The watermark density is set to a level that is too low.	Check the density settings.
	Watermarks cannot be printed in graphics applications.	No watermark can be printed in this case.
The staple function cannot be specified.	Stapling is not possible if "Paper Type" is set to "Thick" or "Transparency".	Check each setting in the printer driver.
	The staple function requires optional finisher.	Install the required optional finisher and enable it using the printer driver.
Stapling cannot be performed.	If are a large number of pages to be printed, stapling cannot be performed.	Change the number of pages to be printed.
	Stapling is not possible if the document contains pages of different sizes.	Check the document.

Symptom	Probable Cause	Action
The stapling position is not as expected.	The orientation setting is not correct.	Check the stapling position in the printer driver setup dialog box.
The hole punch function cannot be specified.	Hole punching cannot be specified if "Booklet", "Transparency", "Thick2", "Thick3", or "Envelope" is selected.	Check each setting in the printer driver.
	A punch kit must be installed on an optional finisher.	Install the required optional finisher and enable it using the printer driver.
The pages are not punched.	Printed pages may be fed out without being punched if the paper is loaded into the paper source with an incorrect orientation.	Check the orientation setting.
The hole punch position is not as expected.	The orientation setting is not correct.	Check the punch position on the Layout tab of the printer driver setup dialog box.
The form is not printed properly.	Available computer memory space is not sufficient.	Simplify the form to reduce the data size.
The image is not printed properly.	Available computer memory space is not sufficient.	Simplify the image to reduce the data size.
Paper is not fed from the specified paper source.	Paper will not be fed from the specified paper source if that paper source is loaded with paper of a different size or orientation.	Load the paper source with paper of the appropriate size and orientation.
The access number cannot be specified.	To specify access numbers, a hard disk must be added in the Option tab of the printer driver.	Add a hard disk in the Option tab of the printer driver.

## 6.3 Error Message



Message	Cause and Remedy
Cannot connect to the network.	A connection to the network could not be established. Check if the network cable is correctly connected. In addition, check that the Network Setting parameters on the Administrator Setting screen have been correctly specified.





## 7 Appendix

### 7.1 Specifications

Item		Specifications
Model		Built-in printer controller
Power Supply		Common with the main body
CPU		PPC750 FX 466 MHz
RAM		512 MB
Hard Disk		40 GB
Interface		Standard: Ethernet (10Base-T or 100Base-TX) Optional: USB 1.1, USB 2.0, or IEEE 1284
Frame Type		Ethernet 802.2 Ethernet 802.3 Ethernet II Ethernet SNAP
Supported Protocols		TCP/IP IPX/SPX NetBEUI AppleTalk (EtherTalk)
Print Speed		25 pages/minute (color/monochrome, 8-1/2 × 11  paper, and simplex) 23 pages/minute (color/monochrome, 8-1/2 × 11  paper, and duplex)
Fast Print Time		11.7 seconds or less (color and A4 paper) 8.4 seconds or less (monochrome and A4 paper)
Printer Language		PCL5e/c Emulation PCL6 (XL 2.1) Emulation PostScript 3 Emulation (3011)
Operating Environment Conditions		Temperature 10 to 30°C Humidity 15—85% RH
Resolution	Data Processing	600 × 600 dpi (printing and fax operations) 400 × 400 dpi (fax operations) 200 × 200 dpi (fax operations)
	Printing	600 × 1800 dpi (equivalent)
Supported Paper Sizes		Maximum Standard Size
Printer Fonts		PCL Latin 80 Fonts Postscript 3 Emulation Latin 136 Fonts
Compatible Computers		IBM PC or compatible, and Macintosh (PowerPC or Intel Processor)

Item		Specifications
Supported Operating Systems	Server	Windows NT 4.0 (SP6a), Windows 2000 Server, or Windows Server 2003
	Client	Windows 98 Second Edition, Windows Me, Windows 2000, Windows XP, or Windows NT 4.0 (SP6a) MacOS 9.2 or later or MacOS X 10.2, 10.3 or 10.4
Printer Driver		PCL6: <ul style="list-style-type: none"> <li>• Windows 98 Second Edition or Windows Me Printer Driver</li> <li>• Windows 2000, Windows XP, or Windows Server 2003 Printer Driver</li> <li>• Windows NT 4.0 Printer Driver</li> </ul> PS3: <ul style="list-style-type: none"> <li>• Windows 98 Second Edition or Windows Me PPD File</li> <li>• Windows NT 4.0 Printer Driver</li> <li>• Windows 2000, Windows XP (Home/Professional), Windows Server 2003 Printer Driver</li> <li>• Windows XP Professional x64, Windows Server 2003 x64 Printer Driver</li> <li>• MacOS 9.2 PPD File</li> <li>• MacOS X 10.2 Printer Driver</li> <li>• MacOS X 10.3 or MacOS X 10.4 Printer Driver</li> </ul>
Utility		PageScope Web Connection Web Browsers: Microsoft Internet Explorer 6 or later recommended (JavaScript enabled, Cookies enabled) Microsoft XML Parser MSXML3.X must be installed when using Internet Explorer 5.5. Netscape Navigator 7.02 or later (JavaScript enabled, Cookies enabled) Macromedia® Flash® (If "Flash" is selected in View Mode, version 7.0 or later plugin is required.)

## 7.2 Configuration Page

### KONICA MINOLTA C252

#### Configuration Page

<i><u>Print Operation Menu Map</u></i>		<i><u>Installed</u></i>	
<b>Basic Setting</b>		Printer HDD	= Installed
Default Paper Size	= A4	Printer Memory	= 512 [ MByte ]
Paper Tray	= Auto	<i><u>Printer Information</u></i>	
Output Tray	= Elevate Tray	<b>Installed Tray</b>	
Binding Position	= Left Binding	Tray 1	= None
Double-Sided	= Off	Tray 2	= 8 1/2x11
Staple	= Off	Tray 3	= A3
Hole-Punch	= Off	Tray 4	= None
Orientation	= Portrait	LCT	= None
# of Sets	= 1	<b>Option</b>	
No Matching Paper in Tray Setting	= Stop Printing (Tray Fixed)	Duplex Unit	= None
Spool Setting	= On	Finisher	= Available
Convert	= Off	Punch Unit	= Available
PDL Setting	= Auto	Fold Unit	= Available
Banner Setting	= Disable	Fax Unit	= Not Available
Banner Paper Tray	= Auto	Mailbin Unit	= Not Available
<b>PCL Setting</b>		<i><u>Firmware Version</u></i>	
Font Source	= 1	Printer Controller	= 4038-3000-0000-0000
Font Number	= 0	<i><u>Network</u></i>	
Font Point	= 12.00	<b>MAC Address</b>	
Font Pitch	= 10.00	MAC Address	= 00:20:6B:00:00:00
Symbol Set	= PC-8, Code Page 437	<b>TCP/IP</b>	
Line/Page	= 64 [ Line / Page ]	TCP/IP	= Enable
CR/LF Mapping	= Off	IP Address	= 192.168.1.20
<b>PS Setting</b>		Subnet Mask	= 255.255.255.0
Print Reports	= Disable	Default Gateway	= 192.168.1.1
<b>I/F Setting</b>		<b>Netware</b>	
IEEE 1284 Timeout	= 60 [ sec. ]	Netware	= Disable
Network Rx Timeout	= 60 [ sec. ]	<b>Appletalk</b>	
USB Timeout	= 60 [ sec. ]	Appletalk	= Disable
Parallel I/F	= ECP	<b>SMB</b>	
<b>RAW Port No.</b>		SMB	= Enable
RAW Port 0	= 9100		
RAW Port 1	= 9112		
RAW Port 2	= 9113		
RAW Port 3	= 9114		
RAW Port 4	= 9115		
RAW Port 5	= 9116		
<b>Test Print</b>			
Configuration			
PCL Font List			
PS Font List			
Demo Page			

## 7.3 Font List

### PCL Font List

KONICA MINOLTA C252				
PCL Font List			P.1	
Internal Fonts				
Font	Pitch/Point	Escape Sequence	Font #	Font ID
Courier	Scalable	<esc>(01X<esc>(s0p10h0s0b4099T	00000	
CG Times	Scalable	<esc>(01X<esc>(s1p12v0s0b4101T	00001	
<b>CG Times Bold</b>	Scalable	<esc>(01X<esc>(s1p12v0s3b4101T	00002	
<i>CG Times Italic</i>	Scalable	<esc>(01X<esc>(s1p12v1s3b4101T	00003	
<b>CG Times Bold Italic</b>	Scalable	<esc>(01X<esc>(s1p12v1s3b4101T	00004	
CG Omega	Scalable	<esc>(01X<esc>(s1p12v0s0b4113T	00005	
<b>CG Omega Bold</b>	Scalable	<esc>(01X<esc>(s1p12v0s3b4113T	00006	
<i>CG Omega Italic</i>	Scalable	<esc>(01X<esc>(s1p12v1s0b4113T	00007	
<b>CG Omega Bold Italic</b>	Scalable	<esc>(01X<esc>(s1p12v1s3b4113T	00008	
<i>Conrad</i>	Scalable	<esc>(01X<esc>(s1p12v1s0b4116T	00009	
<b>Clarendon Condensed</b>	Scalable	<esc>(01X<esc>(s1p12v4s3b4140T	00010	
Univers Medium	Scalable	<esc>(01X<esc>(s1p12v0s0b4148T	00011	
<b>Univers Bold</b>	Scalable	<esc>(01X<esc>(s1p12v0s3b4148T	00012	
<i>Univers Medium Italic</i>	Scalable	<esc>(01X<esc>(s1p12v1s0b4148T	00013	
<b>Univers Bold Italic</b>	Scalable	<esc>(01X<esc>(s1p12v1s3b4148T	00014	
Univers Condensed Medium	Scalable	<esc>(01X<esc>(s1p12v4s0b4148T	00015	
<b>Univers Condensed Bold</b>	Scalable	<esc>(01X<esc>(s1p12v4s3b4148T	00016	
<i>Univers Condensed Medium Italic</i>	Scalable	<esc>(01X<esc>(s1p12v5s0b4148T	00017	
<b>Univers Condensed Bold Italic</b>	Scalable	<esc>(01X<esc>(s1p12v5s3b4148T	00018	
Antique Olive	Scalable	<esc>(01X<esc>(s1p12v0s0b4168T	00019	
<b>Antique Olive Bold</b>	Scalable	<esc>(01X<esc>(s1p12v0s3b4168T	00020	
<i>Antique Olive Italic</i>	Scalable	<esc>(01X<esc>(s1p12v1s0b4168T	00021	
Garamond Antiqua	Scalable	<esc>(01X<esc>(s1p12v0s0b4197T	00022	
<b>Garamond Halbfett</b>	Scalable	<esc>(01X<esc>(s1p12v0s3b4197T	00023	
<i>Garamond Kursiv</i>	Scalable	<esc>(01X<esc>(s1p12v1s0b4197T	00024	

## PS Font List

## KONICA MINOLTA C252

## PS Font List

P.1

## Internal Fonts

Font	Font #
Albertus MT	AlbertusMT 00000
<i>Albertus MT Italic</i>	AlbertusMT-Italic 00001
Albertus MT Light	AlbertusMT-Light 00002
Antique Olive Roman	AntiqueOlive-Roman 00003
<i>Antique Olive Italic</i>	AntiqueOlive-Italic 00004
<b>Antique Olive Bold</b>	AntiqueOlive-Bold 00005
<b>Antique Olive Compact</b>	AntiqueOlive-Compact 00006
<i>Apple Chancery</i>	Apple-Chancery 00007
Arial	ArialMT 00008
<i>Arial Italic</i>	Arial-ItalicMT 00009
<b>Arial Bold</b>	Arial-BoldMT 00010
<b>Arial Bold Italic</b>	Arial-BoldItalicMT 00011
ITC Avant Garde Gothic Book	AvantGarde-Book 00012
<i>ITC Avant Garde Gothic Book Oblique</i>	AvantGarde-BookOblique 00013
<b>ITC Avant Garde Gothic Demi</b>	AvantGarde-Demi 00014
<b>ITC Avant Garde Gothic Demi Oblique</b>	AvantGarde-DemiOblique 00015
Bodoni Roman	Bodoni 00016
<i>Bodoni Italic</i>	Bodoni-Italic 00017
<b>Bodoni Bold</b>	Bodoni-Bold 00018
<b>Bodoni Bold Italic</b>	Bodoni-BoldItalic 00019
<b>Bodoni Poster</b>	Bodoni-Poster 00020
<b>Bodoni Poster Compressed</b>	Bodoni-PosterCompressed 00021
ITC Bookman Light	Bookman-Light 00022
<i>ITC Bookman Light Italic</i>	Bookman-LightItalic 00023
<b>ITC Bookman Demi</b>	Bookman-Demi 00024
<b>ITC Bookman Demi Italic</b>	Bookman-DemiItalic 00025
Carta	Carta 00026
<b>Chicago</b>	Chicago 00027
<b>Clarendon Roman</b>	Clarendon 00028
<b>Clarendon Bold</b>	Clarendon-Bold 00029

Demo Page

**Test Page**

	R	G	B	RGB
100%				
90%				
80%				
70%				
60%				
50%				
40%				
30%				
20%				
10%				
5%				

--	--	--	--	--	--	--	--	--	--	--	--	--	--	--	--	--	--	--	--	--	--	--	--	--	--	--	--	--	--	--	--	--	--	--	--	--	--	--	--	--	--	--	--	--	--	--	--	--	--	--	--	--	--	--	--	--	--	--	--	--	--	--	--	--	--	--	--	--	--	--	--	--	--	--	--	--	--	--	--	--	--	--	--	--	--	--	--	--	--	--	--	--	--	--	--	--	--	--	--

--	--	--	--

--

<p>The quick brown fox jumps over the lazy dog.</p> <p>The quick brown fox jumps over the lazy dog.</p> <p>The quick brown fox jumps over the lazy dog.</p> <p>The quick brown fox jumps over the lazy dog.</p> <p>The quick brown fox jumps over the lazy dog.</p> <p>The quick brown fox jumps over the lazy dog.</p> <p>The quick brown fox jumps over the laz</p> <p>The quick brown fox jumps over th</p> <p>The quick brown fox jump</p>
--

● This manual was printed using 100% post-consumer recycled paper.

● This manual was printed with soy ink.



**KONICA MINOLTA**

<http://konicaminolta.com>